



Integrated Amplifier

A-S2200

Owner's Manual

Thank you and congratulations on your purchase of this Yamaha product.



- You can enjoy the high-quality stereo sound of this integrated amplifier at home.
- To use the product properly and safely, we suggest that you read this manual and the “Safety Brochure” thoroughly. Keep the manual in a safe, accessible place for future reference.

Features

- ◆ **Floating balanced circuit for power amplifier**
- ◆ **Fully-balanced transmission from input to output**
- ◆ **Tone control circuit with a parallel volume system**
- ◆ **Large power supply with four separate circuits**
- ◆ **Left-right symmetrical design**
- ◆ **Fully discrete phono amp**
- ◆ **Low-impedance, high-performance headphone amp**

Things to know before using this product

About this manual

- This manual describes the unit's features and connection procedures.
- The illustrations as shown in this manual are for instructional purposes only.
- Specifications and appearance are subject to change without notice.
-  **WARNING** describes precautions to be followed to avoid the possibility of serious injury or even death.
-  **CAUTION** describes precautions to be followed to avoid injury.
- **NOTICE** describes precautions to be followed to avoid malfunction or damage to the product.
- **Note** describes supplemental information about the product.

Supplied accessories

Please make sure that the following accessories are included in the package.

- Remote control
 - Batteries (AAA, R03, UM-4) (×2)
 - Power cable*
 - Owner's Manual (this book)
 - Safety Brochure
- * Multiple power cables might be included in the package depending on the area of distribution. Please use the one that is appropriate for your AC outlet.

Table of Contents

Features	3	Bi-wired connection	19
Things to know before using this product ..	4	Balanced connection	20
About this manual.....	4	Trigger connection	20
Supplied accessories.....	4	Remote connection	21
Part Names and Functions	5	Operating the unit from another room.....	21
Front panel.....	6	Remote connection between	
Rear panel	10	Yamaha components.....	21
Remote control.....	12	Connecting the power cable	22
Installing batteries in the remote control ..	14	Appendix	23
Operating the remote control.....	14	Specifications	24
Connections	15	Block diagram	26
Connection diagram	16	Acoustic characteristics	27
Connecting speakers	18	Tone control characteristics	27
Using speaker cables	18	Total harmonic distortion	27
Using banana plug cables.....	19	Total harmonic distortion (PHONO).....	28
Using Y-shaped lug cables	19	Troubleshooting	29
		Maintenance	30

Part Names and Functions

This section lists the names and describes the function of various parts on the front and rear panels, and the remote control.

Part Names and Functions

Front panel

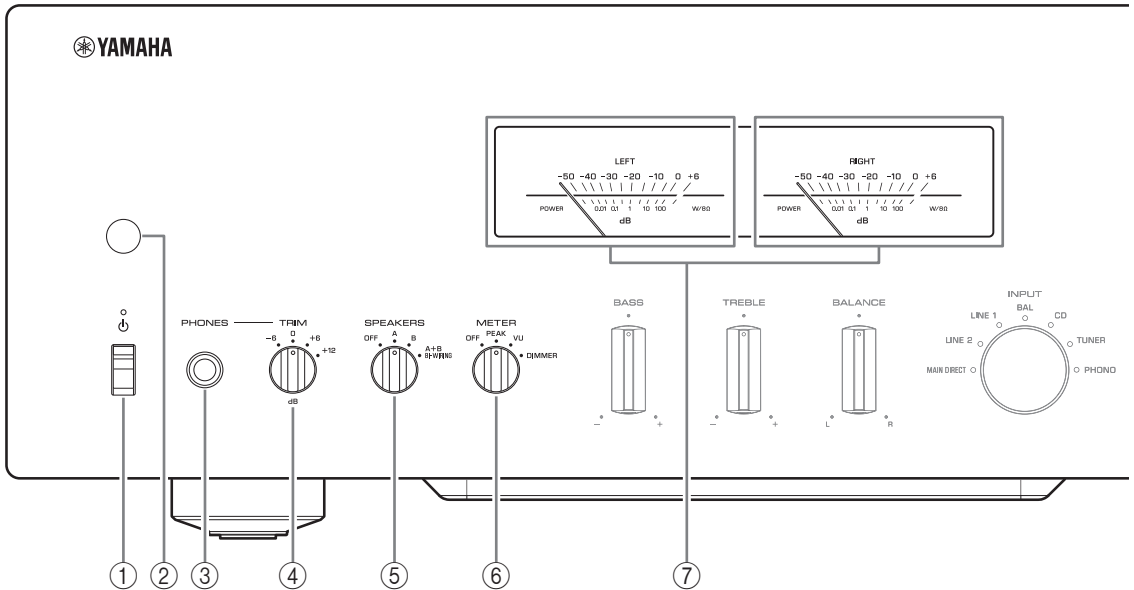

① ⏻ (Power) switch/indicator

⏻ (Power) switch	Power status	Indicator
Up position	On	Lit brightly
	Standby	Lit dimly
Down position	Off	Off

While the ⏻ (Power) switch is in the up position, press the ⏻ AMP key on the remote control repeatedly to switch the power to the unit between on and standby mode. In addition, under either of the following conditions, the unit will enter standby mode.

- If the Auto Power Standby function is enabled. (→ page 10)
- If you turn off the power to a device that has been set to trigger connection to this unit. (→ page 20)

NOTICE

If you plan not to use the unit for an extended period of time, be sure to unplug the power plug from the AC outlet. Even when the power is turned off, a minimal amount of electric current is still flowing to the unit.

Note

- After you turn on the unit, it will take a few seconds before the unit can reproduce sound.
- Do not turn on the power to this unit again within 10 seconds after the power has been turned off. Doing so may generate noise.
- While the unit is in standby mode, to turn on power to the unit first set the ⏻ (Power) switch to the down position to turn the power off, then set the switch to the up position.
- While the unit is in standby mode, if you unplug the power cable from the AC outlet and then plug it in again, the power to the unit will be turned on.

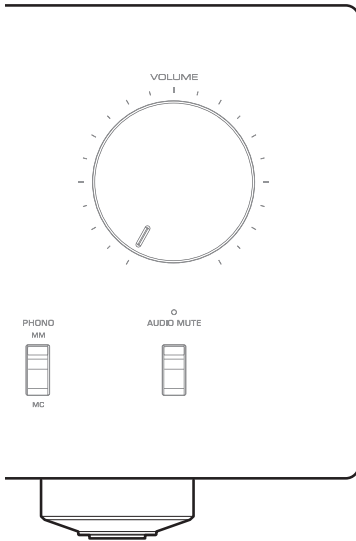

② Remote control sensor

Receives signals from the remote control. (→ page 14)

③ PHONES jack

Connect your headphones here.

Note

- Connecting the headphones here will result in the following:
 - No sound will be heard from the connected speakers.
 - Audio signals will not be output at the PRE OUT jacks.
 - You will be unable to select MAIN DIRECT as the input source.
- If MAIN DIRECT is selected as the input source, audio signals will not be output at the PHONES jack.

④ TRIM selector

Switches the headphone amp gain. Select the gain setting that is appropriate for your headphones.

Available gain:

-6 dB, 0 dB, +6 dB, +12 dB

⑤ SPEAKERS selector

Switches sets of speakers connected to the SPEAKERS L/R CH A and B terminals on the rear panel as follows:

OFF: No audio signals will be output from the speakers.

A: Audio signals will be output from the set of speakers connected to the A terminals.

B: Audio signals will be output from the set of speakers connected to the B terminals.

A+B BI-WIRING: Audio signals will be output from the sets of speakers connected to the A and B terminals. Select this position when you plan to make a bi-wired connection. (→ page 19)

NOTICE

[Model for Asia]

If you connect two sets of speakers (A+B), use the speakers with an impedance of 12Ω or higher.

[Other models]

If you connect two sets of speakers (A+B), use the speakers with an impedance of 8Ω or higher.

⑥ METER selector

Switches the meter function as follows:

OFF: Turns off meter operation and display illumination.

PEAK: Switches the meter display type to a peak level meter. The peak level meter shows the highest instantaneous level of an audio output signal.

VU: Switches the meter display type to a VU (Volume Unit) level meter. The VU level meter shows an effective audio output value that represents the way sound is perceived by human ears.

DIMMER: When selected, the DIMMER automatically changes the brightness of the meter display in steps. When you see the brightness level you desire, switch to another setting parameter to lock in the new brightness setting.

⑦ Meter (LEFT/RIGHT)

Indicates the audio output level of the left (LEFT) and right (RIGHT) channels.

Part Names and Functions

Front panel

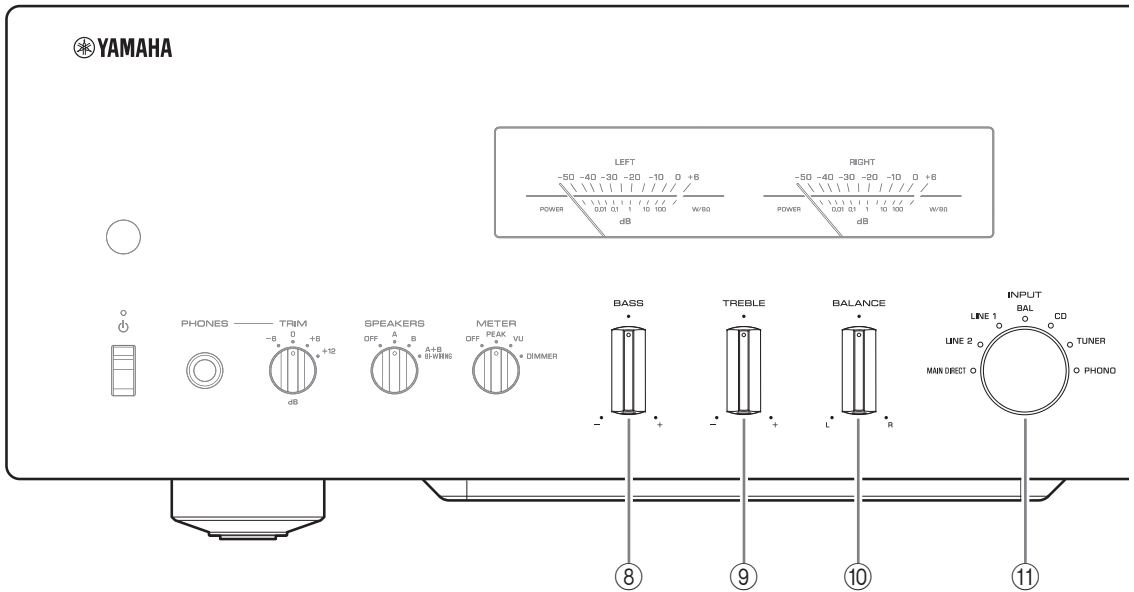

⑧ BASS control

Adjusts the volume level of the bass range.

Adjustable range: -10 dB – 0 – +10 dB

⑨ TREBLE control

Adjusts the volume level of the treble range.

Adjustable range: -10 dB – 0 – +10 dB

⑩ BALANCE control

Adjusts the audio output balance between the left and right speakers to compensate for sound imbalances caused by speaker locations or listening room conditions.

Note

- If both BASS and TREBLE controls are set to 0 (zero), the audio signal will bypass the tone control circuit.
- The BASS, TREBLE, and BALANCE control settings will not affect the input signals at the MAIN IN jacks nor the output signals at the LINE 2 OUT jacks.

⑪ INPUT selector/indicator

Selects the input source. The indicator for the selected input source lights up. Audio signals of the selected input source will be output at the LINE 2 OUT jacks.

MAIN DIRECT: Selects the component connected to the MAIN IN jacks as the input source.

LINE 1/LINE 2: Selects the component connected to the LINE 1 or LINE 2 jacks as the input source.

BAL: Selects the component connected to the BAL input jacks as the input source.

CD: Selects the CD player connected to the CD input jacks as the input source.

TUNER: Selects the tuner connected to the TUNER input jacks as the input source.

PHONO: Selects the turntable connected to the PHONO input jacks as the input source.

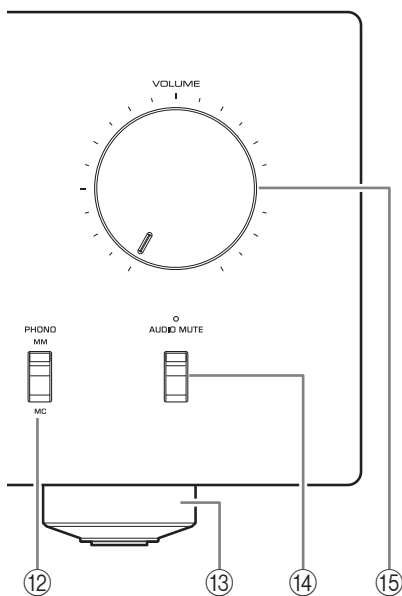

Note

- If MAIN DIRECT is selected as the input source, audio signals will not be output at the PRE OUT, LINE 2 OUT or PHONES jacks.
- If LINE 2 is selected, audio signals will not be output at the LINE 2 OUT jacks.

⑫ PHONO switch

Set this switch to the MM or MC position according to the type of magnetic cartridge of the turntable connected to the PHONO input jacks on the rear panel.

Note

Before you replace the cartridge for the turntable, be sure to turn off the power to this unit.

⑬ Feet

If the unit is unstable, adjust the height of the feet as needed by rotating them.

⑭ AUDIO MUTE switch/indicator

Press this switch to reduce the current volume level by approximately 20 dB. The indicator will light up. Press again to restore the audio output to the previous volume level. The indicator will turn off.

⑮ VOLUME knob

Adjusts the volume level. This setting will not affect the output level at the LINE 2 OUT jacks.

NOTICE

If you select MAIN DIRECT as the input source for this unit, the volume level will be fixed. In this case, to adjust the volume level, use the volume control on the external amplifier connected to the MAIN IN jacks.

Part Names and Functions

Rear panel

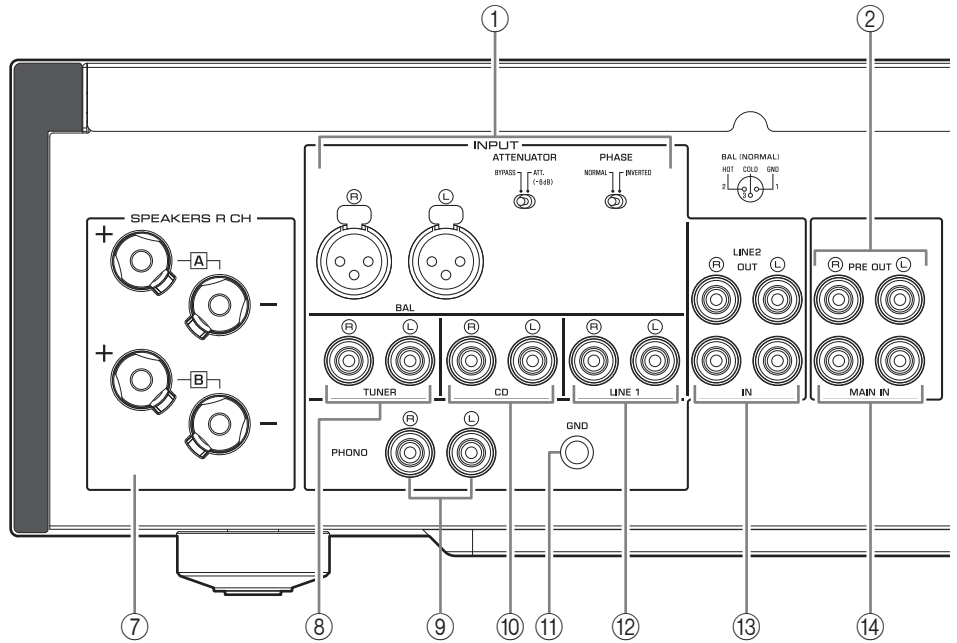

① BAL (balanced) input jacks

Note

Set the ATTENUATOR selector and PHASE selector appropriately for the playback component that is connected to these jacks. (→ page 20)

② PRE OUT jacks

Note

- Audio signals output at the PRE OUT jacks are the same channel signals that are output at the SPEAKERS L/R CH terminals.
- The following parameter settings are effective for audio signals output at the PRE OUT jacks.
 - BASS
 - TREBLE
 - BALANCE
 - VOLUME

③ AUTO POWER STANDBY switch

ON: The unit enters standby mode automatically if it is left turned on and not operated for eight hours (Auto Power Standby function).

OFF: The unit does not enter standby mode automatically.

④ TRIGGER IN jack

Connect external components that support the trigger function. (→ page 20)

⑤ REMOTE IN/OUT jacks

Connect external components that support the remote function. (→ page 21)

⑥ SERVICE jack

This jack is used to test the product.

⑦ SPEAKERS L/R CH terminals

⑧ TUNER input jacks

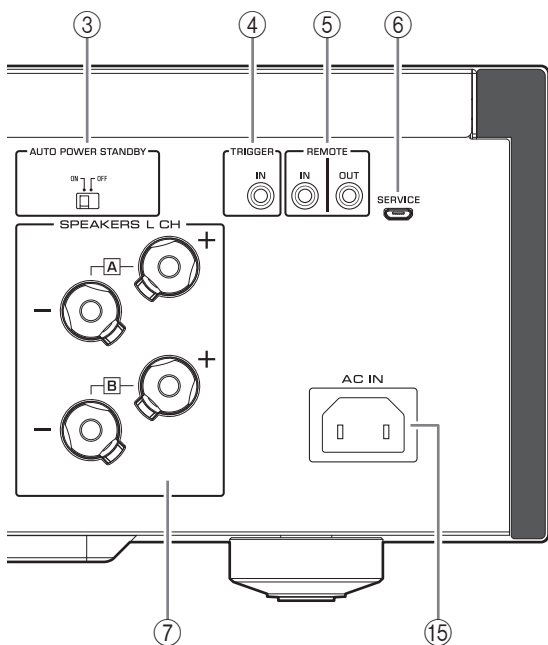

⑨ **PHONO input jacks**

⑩ **CD input jacks**

⑪ **GND (Ground) terminal**

If you connect your turntable to this unit, ground it to the GND terminal. Doing so may reduce noise.



CAUTION

Do not loosen the GND terminal knob excessively. Otherwise, the knob may come off and a child may swallow it accidentally.

Note

This is not a safety ground.

⑫ **LINE 1 input jacks**

⑬ **LINE 2 jacks**

Connect external components that feature analog audio in/out jacks.

⑭ **MAIN IN jacks**

Connect external components that feature a volume control function so that you can use this unit as a power amplifier.

NOTICE

If you select MAIN DIRECT as the input source for this unit, the volume level will be fixed. In this case, to adjust the volume level, use the volume control on the external amplifier connected to the MAIN IN jacks.

⑮ **AC IN jack**

Connect the supplied power cable here. (→ page 22)

Part Names and Functions

Remote control

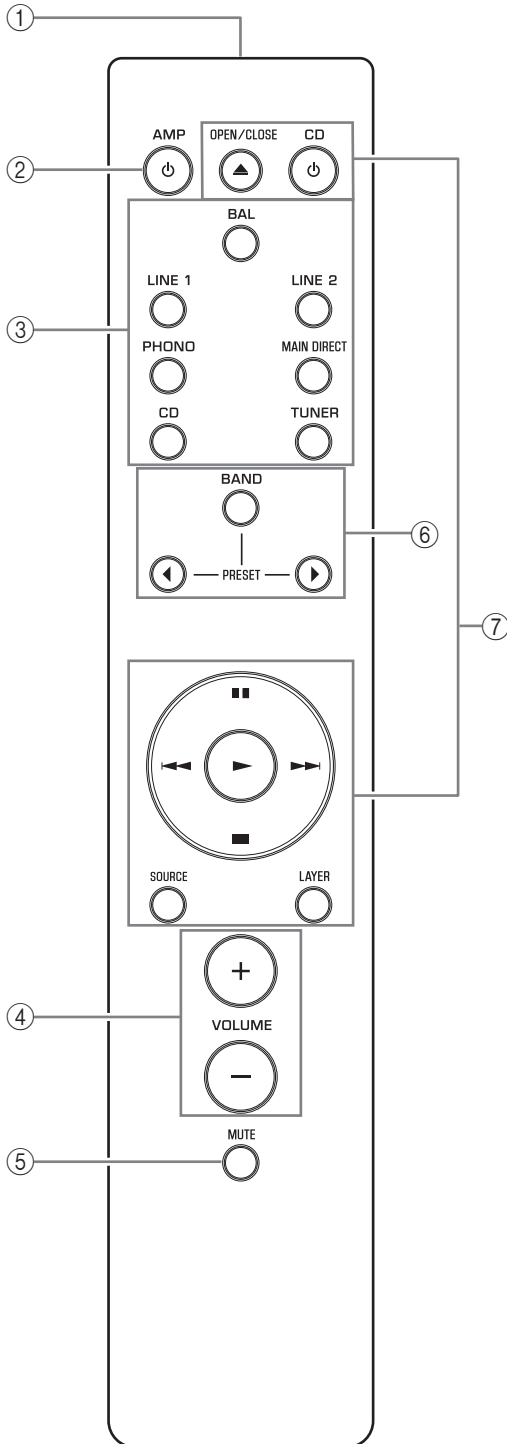

① Infrared signal transmitter

Outputs infrared control signals toward the unit.
(→ page 14)

② AMP key

Turns on the power to the unit or switches it to standby mode. (→ page 6)

③ Input select keys

Select the input source.

Audio signals of the selected input source will be output at the LINE 2 OUT jacks.

BAL: Selects the component connected to the BAL input jacks as the input source.

LINE 1/LINE 2: Selects the component connected to the LINE 1 or LINE 2 jacks as the input source.

PHONO: Selects the turntable connected to the PHONO input jacks as the input source.

MAIN DIRECT: Selects the component connected to the MAIN IN jacks as the input source.

CD: Selects the CD player connected to the CD input jacks as the input source.

TUNER: Selects the tuner connected to the TUNER input jacks as the input source.

Note

- If MAIN DIRECT is selected as the input source, audio signals will not be output at the PRE OUT, LINE 2 OUT or PHONES jacks.
- If LINE 2 is selected, audio signals will not be output at the LINE 2 OUT jacks.

④ VOLUME +/- keys

Adjust the volume level. This setting will not affect the output level at the LINE 2 OUT jacks.

NOTICE

If you select MAIN DIRECT as the input source for this unit, the volume level will be fixed. In this case, to adjust the volume level, use the volume control on the external amplifier connected to the MAIN IN jacks.

⑤ MUTE key

Press this key to reduce the current volume level by approximately 20 dB. Press the key again to restore the previous volume level.

⑥ Tuner control keys

Control the functions of a connected Yamaha tuner. For more information, refer to the owner's manual for your tuner.



⑦ CD player control keys

Control the functions of a connected Yamaha CD player. For more information, refer to the owner's manual for your CD player.



 **OPEN/CLOSE key:** Opens or closes the disc tray of a connected CD player.

 **CD key:** Turns on the power to a connected CD player, or switches it to standby mode.

 **(Play):** Starts playback of the CD player.

 **(Pause):** Pauses playback of the CD player. Press  or  to resume playback.

 **(Stop):** Stops playback of the CD player.

 /  **(Skip):** Skips to the next track, or returns to the beginning of the current track.

SOURCE key: Selects the source to be played on the CD player. The playback source changes each time this key is pressed.

LAYER key: Toggles the playback layer of a hybrid super audio CD between "Super audio CD" and "CD."

Note

Some Yamaha tuners or CD players might not support the tuner or CD player control keys.

Part Names and Functions

■ Installing batteries in the remote control

1 Remove the battery compartment cover.

2 Insert two batteries (AAA, R03, UM-4) according to the polarity markings (+ and -) on the inside of the battery compartment.

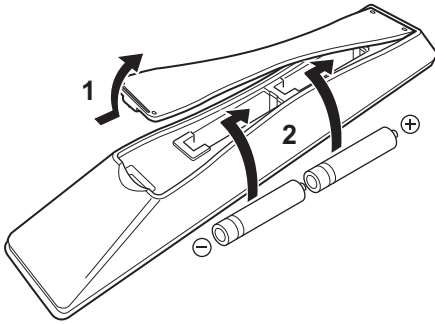

3 Reinstall the battery compartment cover.

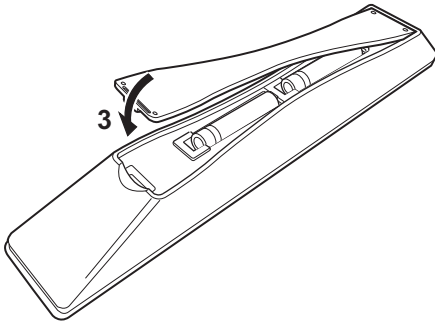

■ Operating the remote control

Operate the remote control in the range shown below by pointing it toward the remote control sensor on the front panel of the unit.

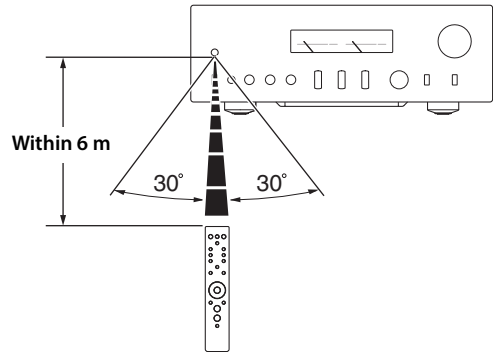

Connections

This section explains how to connect the unit to speakers and audio source components.

Connections

Connection diagram



CAUTION

Be sure to complete all connections before plugging in the power cable to an AC outlet. (→ page 22)

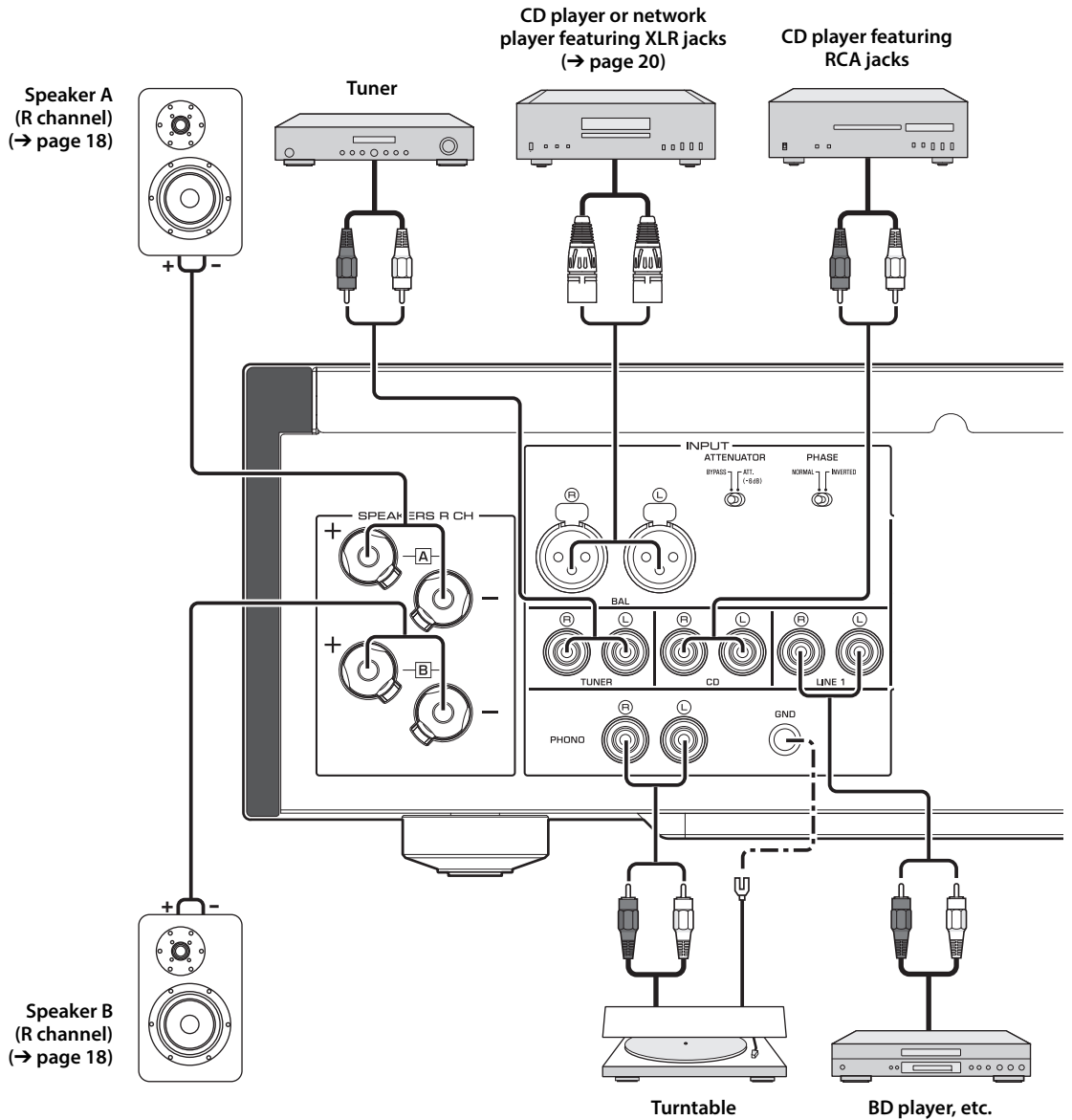

NOTICE

If a component is connected to the MAIN IN jacks, the unit's volume level will be fixed. Therefore, do not connect a CD player or other components that do not feature volume adjustment to the MAIN IN jacks. Otherwise, a loud sound may be emitted, resulting in malfunction of the unit or damage to the speakers.

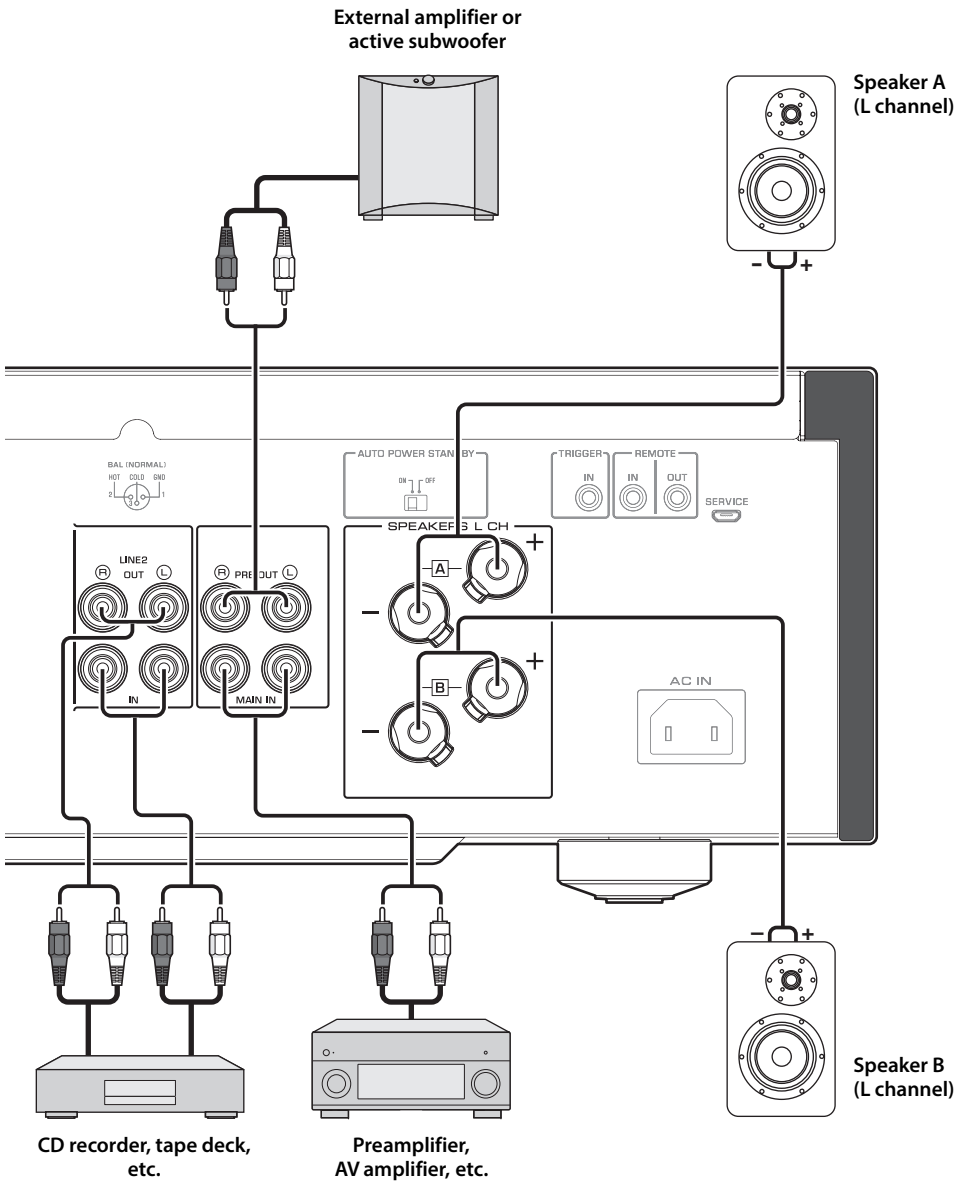

Connections

Note

- Because this power amplifier is of the floating balanced type, the following connections are not possible.
 - Connecting between two "+" (or two "-") terminals of the left and right channels (Fig. 1).
 - Connecting each "-" terminal of the unit's left and right channels to the opposite channel speakers (cross connection, Fig. 2).
 - Connecting the left/right channel "-" terminals (or accidentally allowing them to come in contact) with the metal part of the rear panel of this unit.

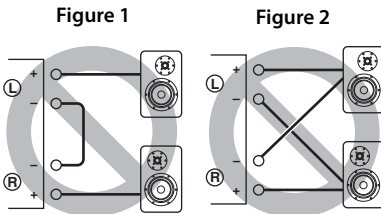

- Do not connect an active subwoofer to the SPEAKERS L/R CH terminals. Connect the subwoofer to the unit's PRE OUT jacks.

Connecting speakers

■ Using speaker cables

- 1 Remove approximately 10 mm of insulation from the end of each speaker cable, and twist the exposed wires together tightly to prevent short circuits.**

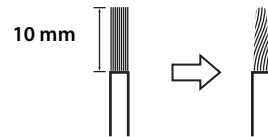

- 2 Unscrew the knob on each speaker terminal, and then insert the bare wire into the side hole on the terminal.**

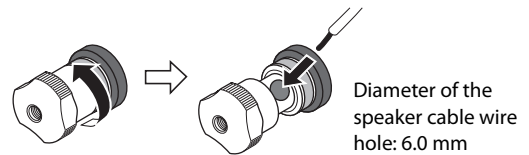

- 3 Tighten the knob.**



⚠ CAUTION

- Do not loosen the knob excessively. Otherwise, the knob may come off and a child may swallow it accidentally.
- To reduce the risk of electric shock, do not touch the speaker terminals while the power to the unit on.

NOTICE

- If the SPEAKERS terminals come into contact with a metallic rack, a short circuit may occur, resulting in damage to this unit. When installing the unit in a rack, maintain a sufficient clearance to prevent the SPEAKERS terminals from coming into contact with the rack.
- Do not let the bare speaker wires touch each other, nor let them touch any metal part of this unit. Otherwise, the unit and/or the speakers may be damaged.

Note

All connections must be correct: L (left) to L, R (right) to R, "+" to "+", and "-" to "-". For information regarding the connection procedure, refer to the owner's manual for your speakers.

■ Using banana plug cables

(Models for U.S.A., Canada, Australia, China, and Taiwan)

First tighten the knob on the SPEAKERS terminal, and then insert the banana plug into the head of the knob.

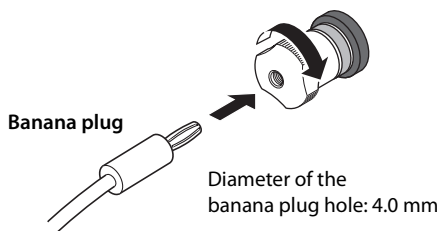

■ Using Y-shaped lug cables

1 Unscrew the knob, and then sandwich the Y-shaped lug between the ring part and base of the terminal.

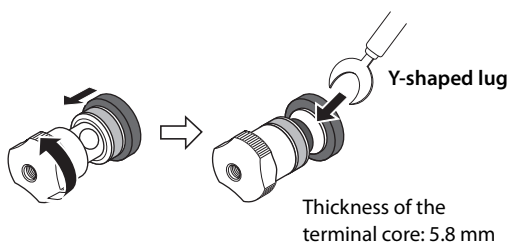

2 Tighten the knob.



Bi-wired connection

A bi-wired connection separates the woofer from the mid and high ranges. Speakers that support bi-wired connection feature two pairs of terminals (total four terminals). These two pairs of terminals can divide the speakers into two independent parts. To make this kind of connection, you need to connect mid and high range drivers to one pair of terminals, and low range drivers to the other pair of terminals.

1 Remove the shorting bars or bridges on the speakers.

2 Connect this unit to the speakers as shown in the figure below.

An example of left channel connection

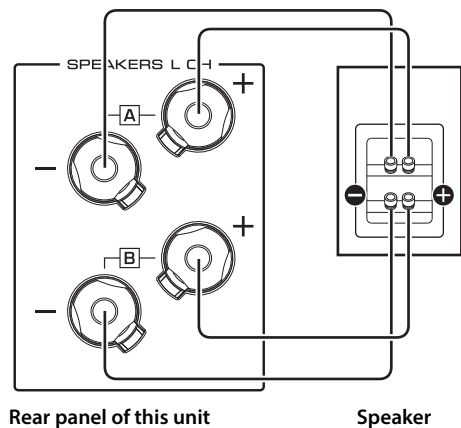

3 Set the SPEAKERS selector on the front panel to A+B BI-WIRING.

Connections

Balanced connection

You can connect a CD player or network player that features XLR-type balanced output jacks to the BAL input jacks of this unit. Use XLR-type balanced cables for this connection.

ATTENUATOR selector: Enables you to set the allowable input level at the balanced input jacks. Select ATT. (–6 dB) if the audio output from the connected component sounds distorted.

PHASE selector: Enables you to set the position (phase) of the HOT pin (pin #2: HOT or pin #3: HOT) at the balanced input jacks.

**NORMAL
(Pin #2: HOT)**

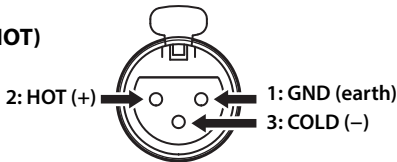

**INV.
(Pin #3: HOT)**

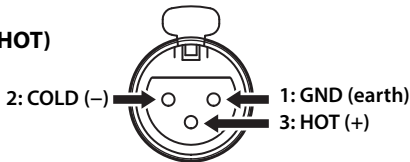

Refer to the instruction manual for the connected component to find out the position of the HOT pin at the balanced output jacks on the component.

Note

- Select NORMAL (pin #2 is HOT) for a Yamaha player.
- Do not use balanced and unbalanced connections for one component simultaneously. Doing so would create a ground loop that could generate static and noise.
- When connecting a cable, be sure to align the pins on the connector with the holes on the jack, and then insert the male XLR connector into the jack until you hear a click. To remove the cable, while pressing and holding down the lever on the BAL input jack, pull out the male XLR connector from the jack.

XLR connector (female)

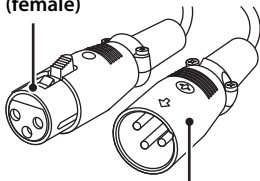

XLR connector (male)

Lever

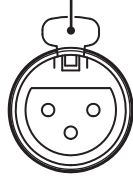

BAL input jack

- For a balanced connection, select BAL as the input source.

Trigger connection

You can connect a Yamaha AV receiver or other component that supports the Trigger function. You can control this unit in sync with a connected component.

Rear panel of this unit

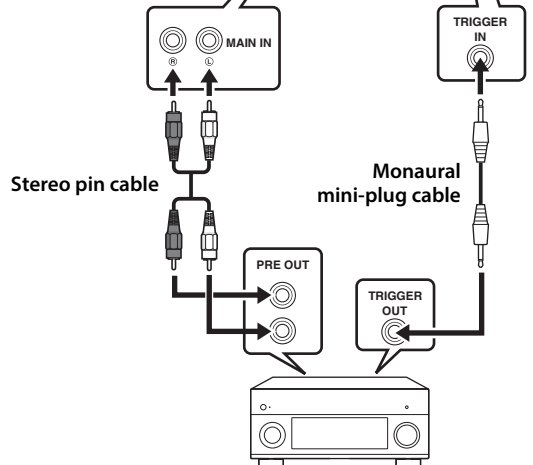
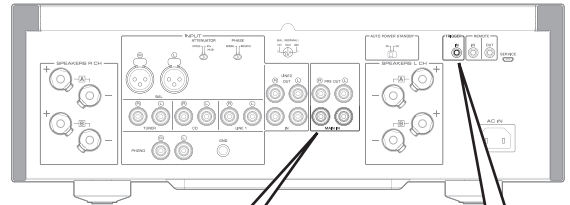

Yamaha AV receiver or other component that features TRIGGER OUT jacks and PRE OUT jacks

When the power to the connected component is turned on, the power to this unit is also turned on. Simultaneously, the input source to the unit is set to MAIN DIRECT. If MAIN DIRECT has been selected as the input source for this unit, when the power to the connected component is turned off, this unit will enter standby mode.

Note

When the power switch on this unit is turned Off, the power to the unit will not be triggered.

Remote connection

■ Operating the unit from another room

If you connect a commercially-available infrared receiver and transmitter to the unit's REMOTE IN/OUT jacks, you will be able to operate the unit and/or external component from another room, using the supplied remote control.

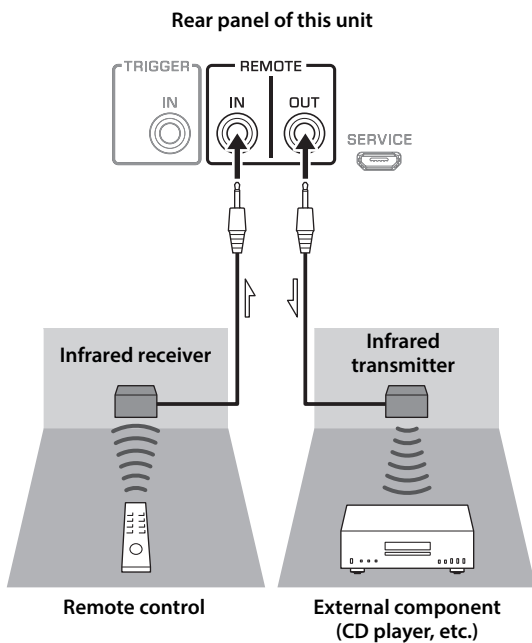

■ Remote connection between Yamaha components

If you have another Yamaha component that supports remote connections, an infrared transmitter is not necessary. Connect an infrared receiver to the unit's REMOTE IN/OUT jacks, as shown below.

Up to 3 Yamaha components (including this unit) can be set up for remote connection.

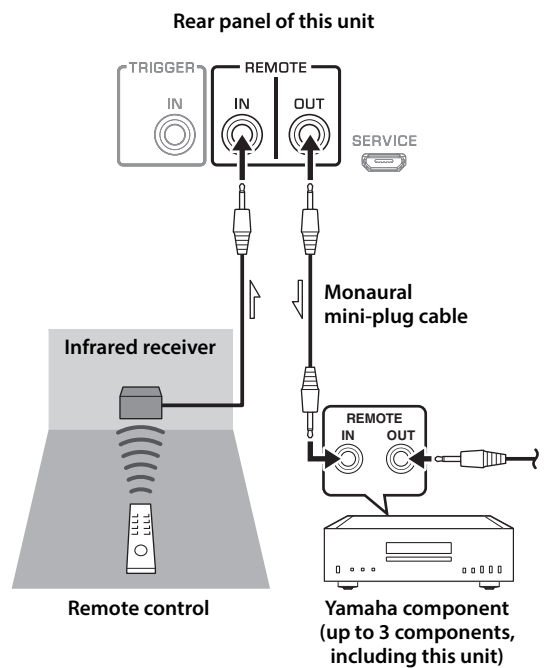

Connections

Connecting the power cable

After all connections are complete, plug the power cable into the AC IN connector of the unit, and then plug the power plug into the AC outlet.

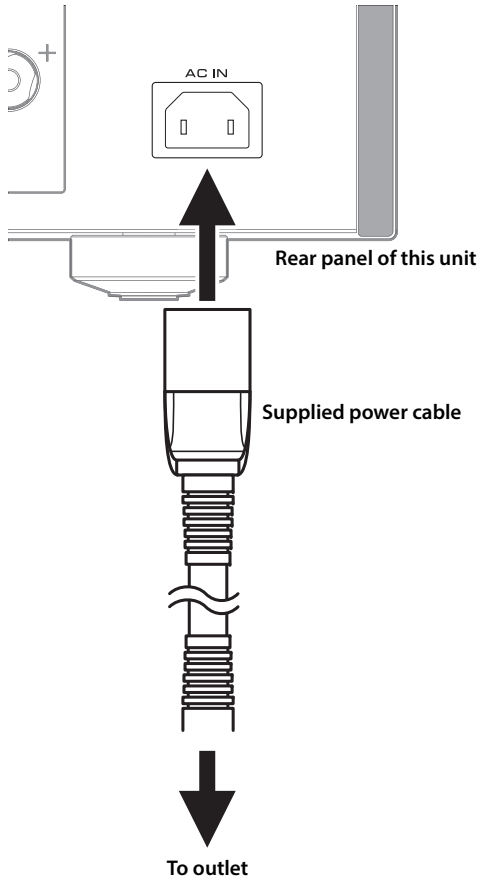

Appendix

This section lists technical specifications for this unit.

Appendix

Specifications

Rated output power (20 Hz to 20 kHz, 0.07% THD)

2-channel driven

[Model for Asia]

8Ω 90 W + 90 W

6Ω 110 W + 110 W

[Other models]

8Ω 90 W + 90 W

4Ω 150 W + 150 W

Dynamic power

8Ω 105 W + 105 W

6Ω 135 W + 135 W

4Ω 190 W + 190 W

2Ω 220 W + 220 W

IEC output power (1 kHz, 0.07% THD)

[Models for U.K. and Europe]

8Ω 95 W + 95 W

Maximum effective output power (JEITA, 1 kHz, 10% THD)

8Ω 120 W + 120 W

4Ω 190 W + 190 W

Power bandwidth (0.1% THD, 45 W) 2-channel driven

8Ω 10 Hz to 50 kHz

Damping factor (1 kHz)

8Ω 250 or higher

Input sensitivity / input impedance (1 kHz, 100 W/8Ω)

PHONO (MC) 150 μVrms / 50Ω

PHONO (MM) 3.5 mVrms / 47 kΩ

CD (or similar) 200 mVrms / 47 kΩ

MAIN IN 1 Vrms / 47 kΩ

BAL 200 mVrms / 100 kΩ

Maximum input / signal voltage (1 kHz, 0.5% THD)

PHONO (MC) 2.0 mVrms

PHONO (MM) 50 mVrms

CD (or similar) 2.80 Vrms

BAL

BYPASS 2.80 Vrms

ATT. (-6 dB) 5.60 Vrms

Rated output voltage / output impedance

LINE 2 OUT 200 mVrms / 1.5 kΩ

PRE OUT 1 Vrms / 1.5 kΩ

Headphone jack rated output power (1 kHz, 32Ω, 0.2% THD)

..... 50 mW + 50 mW

Frequency response

5 Hz to 100 kHz +0 / -3 dB

20 Hz to 20 kHz +0 / -0.3 dB

Deviations from RIAA equalizer

PHONO (MM/MC) ±0.5 dB

Total harmonic distortion plus noise (JEITA, input 0.5 V, 20 Hz to 20 kHz)

2-channel driven

PHONO (MC) → LINE 2 OUT, 1.2 Vrms 0.02%

PHONO (MM) → LINE 2 OUT, 1.2 Vrms 0.005%

CD (or similar)/BAL →

SPEAKERS OUT, 50 W/8Ω 0.035%

Signal-to-noise ratio (JEITA, IHF-A network)

PHONO (MC) 90 dB

PHONO (MM) 96 dB

CD (or similar) 110 dB

BAL 114 dB

Residual noise (IHF-A network)

..... 33 μVrms

Channel separation (JEITA, 1 kHz/10 kHz)

PHONO (MC).....	66/77 dB or higher
PHONO (MM).....	90/77 dB or higher
CD (or similar)/BAL.....	74/54 dB or higher

* The contents of this manual apply to the latest specifications as of the publishing date. To obtain the latest manual, access the Yamaha website and download the manual file.

Tone control characteristics

BASS

Boost/cut.....	50 Hz / ± 9 dB
Turnover frequency.....	350 Hz

TREBLE

Boost/cut.....	20 kHz / ± 9 dB
Turnover frequency.....	3.5 kHz

Power supply

[Models for U.S.A. and Canada]	AC 120 V, 60 Hz
[Model for China].....	AC 220 V, 50 Hz
[Model for Korea].....	AC 220 V, 60 Hz
[Model for Australia].....	AC 240 V, 50 Hz
[Models for U.K. and Europe].....	AC 230 V, 50 Hz
[Model for Asia].....	AC 220–240 V, 50 Hz/60 Hz
[Model for Taiwan].....	AC 110 V, 60 Hz

Power consumption

[Model for Asia]	250 W
[Other models].....	350 W

Standby power consumption

OFF mode.....	0.1 W
Standby mode	0.2 W

Maximum power consumption (1 kHz, 4 Ω 10% THD)

[Model for Taiwan].....	700 W
-------------------------	-------

Dimensions (W \times H \times D)

.....	435 \times 157 \times 463 mm
-------	----------------------------------

Weight

.....	22.7 kg
-------	---------

Appendix

Block diagram

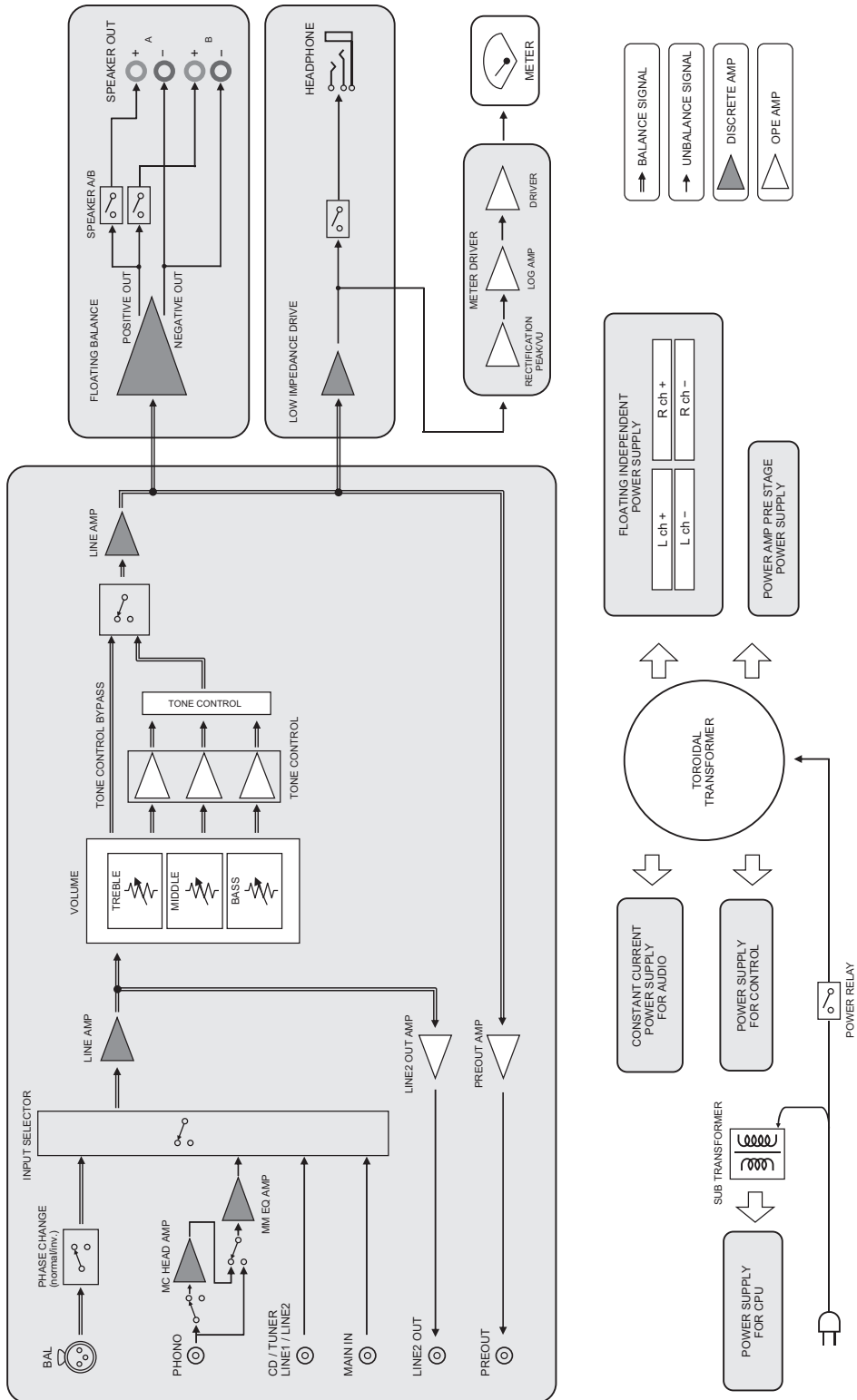

Acoustic characteristics

■ Tone control characteristics

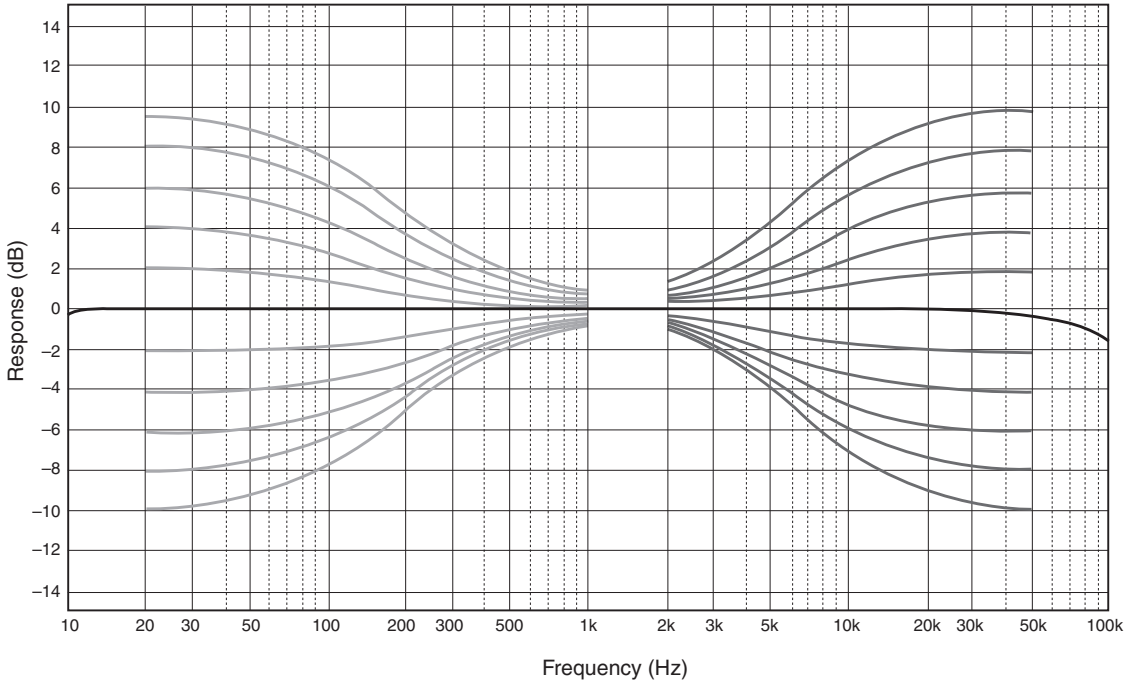

■ Total harmonic distortion

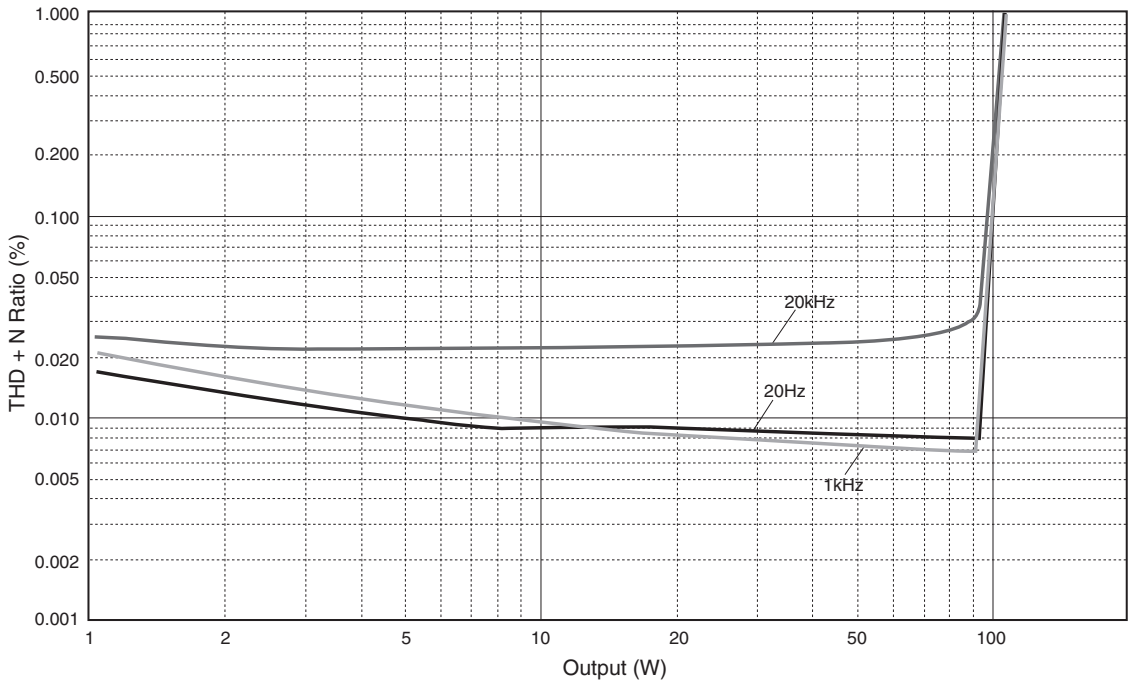

Appendix

■ Total harmonic distortion (PHONO)

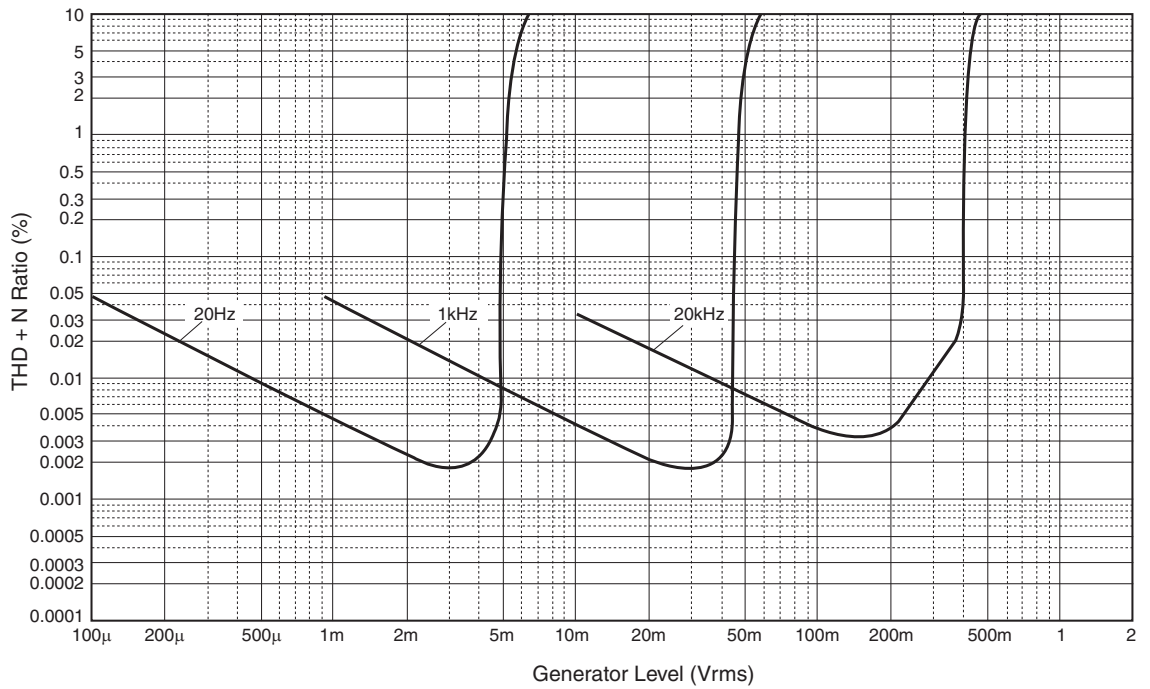

Troubleshooting

Refer to the table below if this unit does not function properly. If the instructions below do not help, or if the problem you are experiencing is not listed below, turn off the unit, disconnect the power plug, and contact the nearest authorized Yamaha dealer or service center.

Problem	Cause	Remedy	See page
Power does not turn on.	The power cable is not connected to the AC IN connector on the rear panel or is not plugged into an AC outlet.	Connect the power cable firmly.	22
	The unit has been exposed to a strong external electric shock (such as lightning or strong static electricity).	Turn off the unit, disconnect the power plug from the AC outlet, wait for about 30 seconds, and then plug the unit in again.	—
The ⏻ (Power) indicator on the front panel flashes.	The protection circuitry has been activated because of a short circuit, etc.	Make sure that the speaker wires are not touching each other or shorting out against the rear panel of the unit, and then turn on the power to the unit.	18
	There is a problem with the internal circuitries of this unit.	Disconnect the power plug from the AC outlet and contact the nearest authorized Yamaha dealer or service.	—
When the unit is powered on, the INPUT indicator flashes and the volume level decreases.	The protection circuitry has been activated because of a short circuit, etc.	Make sure that the speaker wires are not touching each other or shorting out against the rear panel of the unit, and then turn on the power to the unit.	18
No sound is heard.	Incorrect input or output cable connections.	Connect the cables properly. If the problem persists, the cables might be defective.	16
	No appropriate input source has been selected.	Select an appropriate input source using the INPUT selector on the front panel (or one of the input selector keys on the remote control).	8, 12
	The SPEAKERS selector is set to OFF.	Set the SPEAKERS selector to the appropriate position.	7
	The speaker cables are not connected properly.	Make sure that the speaker cables are connected properly.	18
The sound is suddenly muted.	The protection circuitry has been activated because of a short circuit, etc.	Make sure that the speaker wires are not touching each other or shorting out against the rear panel of the unit, and then turn on the power to the unit.	18
The volume level cannot be adjusted.	MAIN DIRECT is selected as the input source.	Adjust the volume level on the connected component. Alternatively, connect the external component to a pair of the input jacks other than the MAIN IN jacks, and then select the corresponding input source.	8
Only one channel speaker can be heard.	The playback component or speakers are not connected properly.	Make sure that they are connected properly. If the problem persists, the cables might be defective.	16
	The volume level balance between the left and right speakers is not adjusted properly.	Adjust the volume level balance between the left and right speakers properly using the BALANCE control.	8

Appendix

Problem	Cause	Remedy	See page
There is a lack of bass and no ambience.	The + and – wires are connected in reverse at the amplifier or the speakers.	Connect the speaker wires to the correct + and – phase.	18
A “humming” noise is heard.	Incorrect input or output cable connections.	Connect the cables properly. If the problem persists, the cables might be defective.	16
	The turntable is not grounded to the GND terminal.	Connect the turntable to the GND terminal of this unit.	16
Playback audio from the component connected to the BAL input jacks sounds distorted.	The level of the signal at the balanced input jacks is exceeding the allowable input level.	If the level of the signal at the XLR-type balanced output jacks on the connected playback component is doubled compared to the RCA unbalanced jacks, set the ATTENUATOR selector located below the input jacks to ATT. (–6 dB).	20
Bass lacks depth when BAL is selected.	The polarity is incorrect.	Select the correct polarity using the PHASE selector.	20
Playback audio is distorted while you listen to a connected CD player or tape deck through headphones (that are connected to a CD player or tape deck).	The power to the unit is turned off.	Turn on the power to the unit.	6
The volume level of the vinyl record is too low.	The PHONO switch on the front panel is set incorrectly.	Set the PHONO switch to the MM or MC position according to the type of magnetic cartridge of the turntable.	9
The remote control does not work or function properly.	The remote control has been used out of the operating range.	The remote control must be used within a maximum distance of 6 m and no more than 30 degrees off-axis from the remote control sensor on the front panel.	14
	Direct sunlight or lighting (from an inverter type of fluorescent lamp, strobe light, etc.) is hitting the remote control sensor on the front panel.	Change the orientation of the lighting or reposition the unit.	—
	The batteries are weak.	Replace all batteries.	14

Maintenance

Mirror-finish side panels

We recommend that you use a cleaning cloth such as those made for pianos.

Other surfaces

Do not use chemical agents, such as benzene or thinner for cleaning. Otherwise, the surfaces might be damaged. Wipe the surfaces using a soft dry cloth.

Yamaha Global Site
<https://www.yamaha.com/>
Yamaha Downloads
<https://download.yamaha.com/>

Manual Development Group
© 2020 Yamaha Corporation
Published 01/2020
IPEM-A0

YAMAHA CORPORATION

10-1 Nakazawa-cho, Naka-ku, Hamamatsu, 430-8650 Japan

AB

VCV3020