

AXC25/35

Manual Generated: 14/11/2022 - 16:01

Table of Contents

AXC25/35	3
Introduction	4
What's included with the AXC25/35?	5
Front panel controls	6
Rear panel connections	7
Remote control	8
Getting connected	9
Operating instructions	10
Troubleshooting	13
Technical specifications	14
Frequently Asked Questions (FAQ)	16

AXC25/35

Last updated: August 2, 2022 02:05. Revision #7158

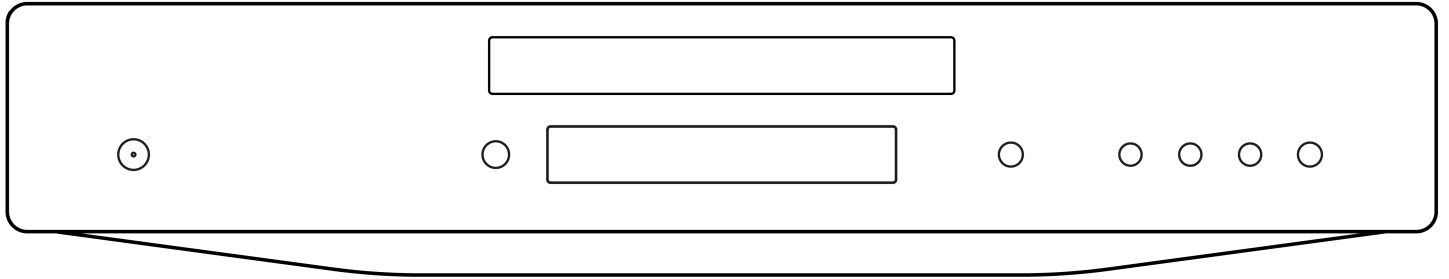

Users Manual

Introduction

Last updated: July 29, 2022 10:27. Revision #7167

This guide is designed to make installing and using this product as easy as possible. Information in this document has been carefully checked for accuracy at the time of printing; however, Cambridge Audio's policy is one of continuous improvement, therefore design and specifications are subject to change without prior notice.

This document contains proprietary information protected by copyright. All rights are reserved. No part of this manual may be reproduced by any mechanical, electronic or other means, in any form, without prior written permission of the manufacturer. All trademarks and registered trademarks are the property of their respective owners.

© Copyright Cambridge Audio Ltd 2022

For upcoming news on future products, software updates and exclusive offers, make sure you register your product at <https://www.cambridgeaudio.com/register>

What's included with the AXC25/35?

Last updated: July 29, 2022 10:27. Revision #7166

Inside the box of your AXC25/35 you will receive:

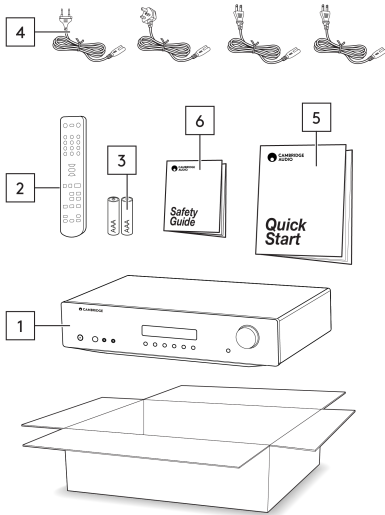

1. AXC CD player.
2. Remote control.
3. 2 x AAA batteries.
4. UK mains lead (Depending on which country the AXA35 was bought).
EU mains lead (Depending on which country the AXA35 was bought).
CU mains lead (Depending on which country the AXA35 was bought).
JP mains lead (Depending on which country the AXA35 was bought).
5. Quick start guide.
6. Safety guide.

Front panel controls

Last updated: August 9, 2022 02:50. Revision #7165

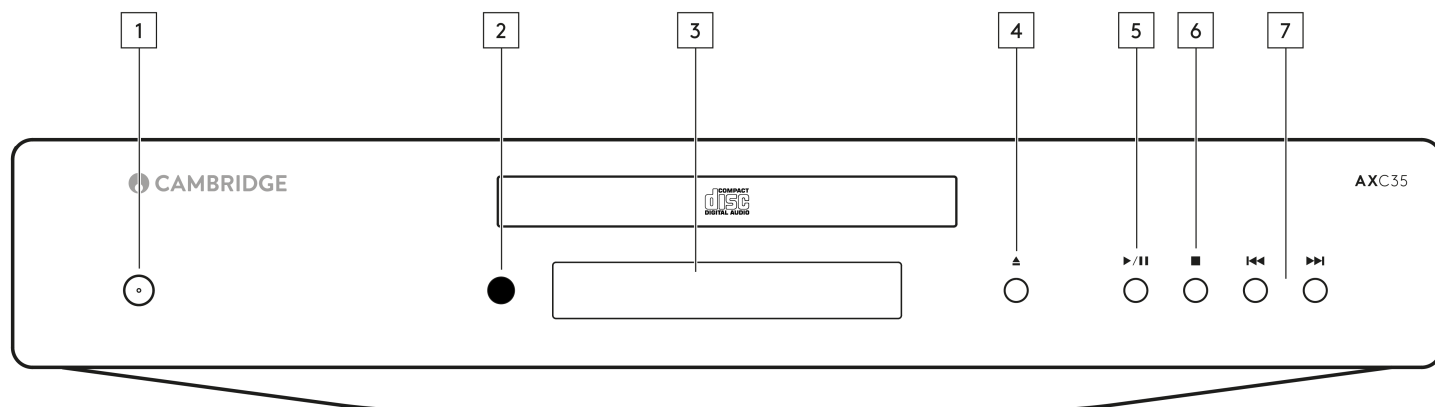

1. Power button - Switches the unit between Standby mode (indicated by dim power LED) and On (indicated by bright power LED). Standby mode is a low power mode where the power consumption is less than 0.5 Watts. This product has APD (Auto Power Down) enabled as default. After inactivity of 20 minutes, the product will automatically switch to Standby.

Auto Power Down (APD) You can enable and disable the unit's APD setting. This can be adjusted by pressing and holding the Power button until the LED flashes in sequence.

The two options below show which option is selected.

Standby flashes 5 times - APD disabled

Standby flashes 10 times - APD enabled

Note: Make sure the unit is On, before making changes to the APD function.

2. Infrared sensor - Receives IR commands from the supplied remote control. An unobstructed line of sight between the remote control and the sensor is required.

3. Display - Alpha-numeric characters which display playback information. On inserting a disc, the CD player will take a few seconds to read the Table of Contents (TOC) information from the disc. The display will then show the number of tracks on the CD and the total length of the CD.

4. Open/Close - Allows you to open and close the disc tray. After placing a CD in the tray, press Open/ Close to close the tray.

5. Play/Pause - Plays the CD and pauses play.

6. Stop - Stops the CD playing.

7. Skip/Scan - Enables you to skip between and search within tracks. Press briefly to skip a track. Press and hold to scan through a track.

Rear panel connections

Last updated: July 29, 2022 10:27. Revision #7164

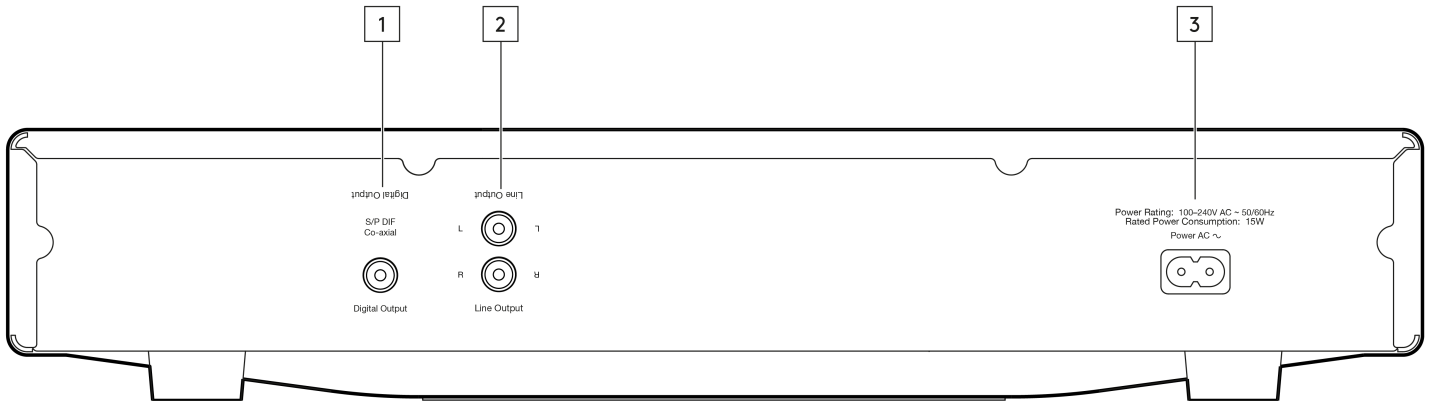

1. S/P DIF CO-AXIAL DIGITAL OUTPUT (AXC35 ONLY) - For input to a separate DAC or digital recording machine. To obtain best results, use a high quality 75 Ohm digital RCA interconnect cable (not one designed for normal audio use).

2. LINE OUTPUT - Use good quality interconnect cables from these sockets to any line level input on your amplifier. For best results and matched performance, we recommend connection to a Cambridge Audio amplifier.

3. AC POWER CABLE - Once you have completed all connections to the amplifier, plug the AC power cable into an appropriate mains socket and turn the unit on. Your compact disc player is now ready for use.

Remote control

Last updated: July 29, 2022 10:27. Revision #7163

The AXC25 and AXC35 are supplied with a remote control that operates the unit. The supplied AAA batteries must be fitted before the remote control can be used.

1. POWER BUTTON - Switches the AXC35/AXC25 between On and low power eco-friendly Standby mode.

2. OPEN/CLOSE - Opens and closes the disc tray.

3. NUMERICAL TRACK SELECT - Press the number of the desired track. The track will then play automatically from the start of the track.

4. PROG - Allows you to program a unique sequence of up to 20 tracks. Refer to 'Operating Instructions' section of this manual for more information.

5. PROG CLEAR - Clears a programmed sequence. See later section of this manual.

6. PAUSE/STOP/PLAY - Press the relevant button to pause, stop or play the CD.

7. SKIP

Right Skip - Press to skip forward by one track on the CD.

Left Skip - Press to skip backward by one track on the CD.

8. SCAN - Press and hold to scan within the selected track. Press the right button to fast forward, the left button to rewind.

9. RANDOM, REPEAT, REMAIN - Read the 'Operating Instructions' section of this manual for information on the functions of these buttons.

AXA35

The following controls on the remote are to operate the AXA35 unit only.

10. VOLUME - Increases or decreases the volume of the unit. Also used to change the bass, treble and balance settings when these are selected.

11. MENU - Toggles between Bass, Treble and Balance options. Use the volume buttons to change the level of the selected option.

12. SOURCE BUTTONS (CD, BD/DVD, MP3/AUX, TUNER, PHONO) - Press the relevant button to select the desired music source.

13. MUTE - Mutes the output of an AXA35.

Note: These controls work on the AXA35 only and are not compatible with Cambridge Audio Azur amplifiers/receivers or units from other manufacturers

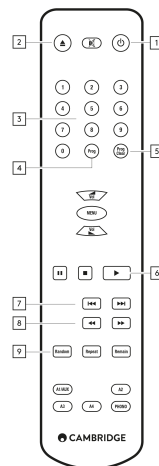

Getting connected

Last updated: August 1, 2022 04:32. Revision #7162

Line Output connection

The line outputs are for connecting to the line level inputs on an amplifier. The diagram below shows a connection to an amplifier.

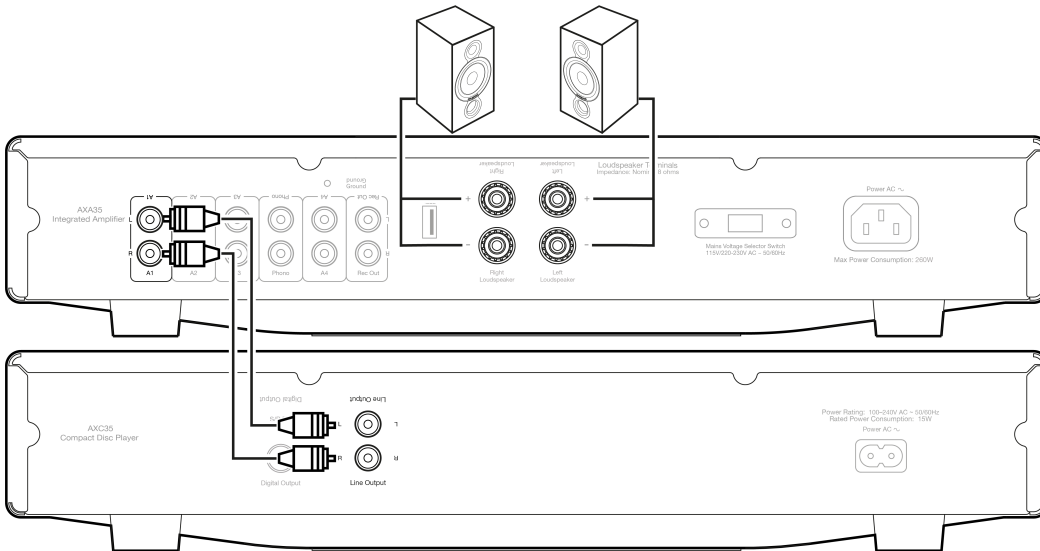

S/P DIF CO-AXIAL Digital Output connection (AXC35 ONLY)

The S/P DIF output is for connecting to the input of a separate digital device, such as a DAC or digital recording machine. The Diagram below shows a connection to an external DAC.

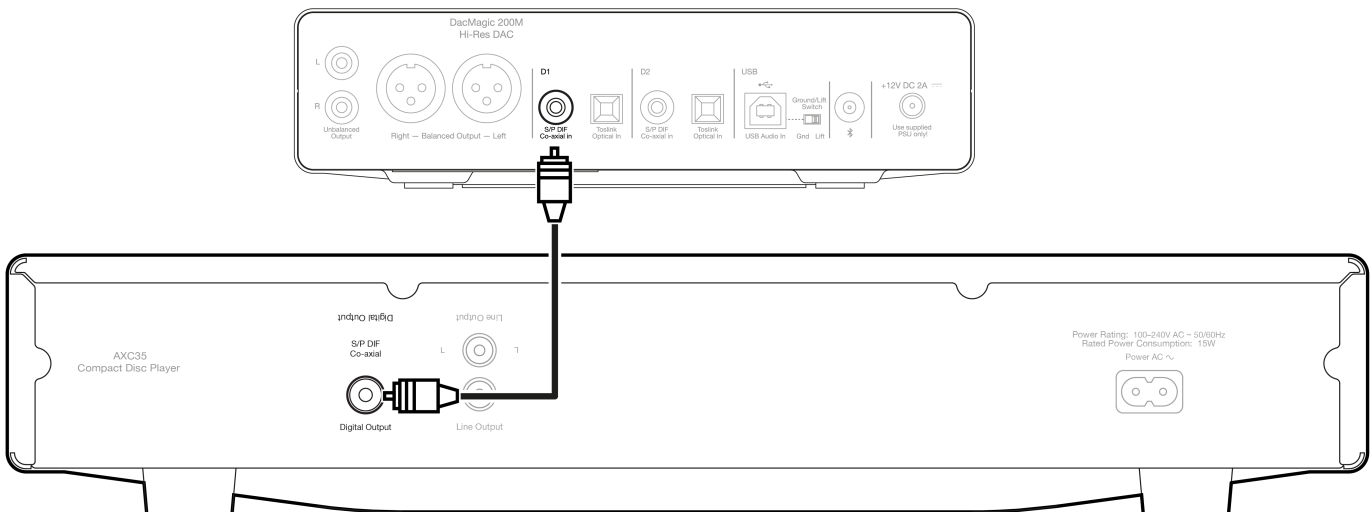

Operating instructions

Last updated: August 1, 2022 04:31. Revision #7161



The AXC25/35 has been designed to only play:

- Compact discs
- Recordable CDs (CD-R)
- Re-writable CDs (CD-RW) bearing the identification logo shown above.

Note: The CD-R/CD-RW discs should contain properly recorded TOC (Table of Contents) information so that they can be played back.

The AXC25/35 can only play the discs recorded in the CDDA format designed for music reproduction or those containing MP3 or WMA files. Do not attempt to play a disc on this unit containing other data, such as a data CD-ROM for PCs.

LOADING AND UNLOADING DISCS

1. Using the front panel or remote control, press the 'Open/Close' button to open the disc tray.
2. Once the disc tray has fully opened, carefully place a disc into the tray with the label side facing upwards.
3. Close the disc tray by pressing the 'Open/Close' button again. When the tray has fully closed the AXC25/35 will read the disc and display the content information.
4. The disc tray can be opened at any time during playback using either the front panel 'Open/Close' button, or the one located on the remote control. Only remove an inserted disc after the disc tray has fully opened.

Important Information:

- Do not put anything except for a compact disc into the disc tray as this can damage the mechanism.
- Do not force the tray by hand during opening and closing operations.
- To avoid dirt and dust entering the mechanism, keep the disc tray closed when not in use.
- If the compact disc that you are attempting to load is badly scratched or dirty, the player may be unable to read or play it.
- Never attempt to load multiple discs into the disc tray at any time.

Normal Disc Play

1. Switch on your amplifier and set its input selector to the correct position. Adjust the volume control to a minimum.
2. Press the Open/Close button to open the disc tray and load a disc.

3. Press the Open/Close button again to close the tray. The CD player will read the disc.
4. To begin playback, press the Play button.
5. When the last track has finished playing, the display will return to Table of Contents (TOC).
6. To stop the disc at any point, press the 'Stop' button. To pause the disc, press the 'Pause' button. Playback can then be resumed by pressing the 'Play' button again.

LOCATING A SPECIFIC TRACK DURING PLAYBACK

1. A single short press of the forward 'Skip/Scan' button will take you to the beginning of the next track on the CD. Repeat as necessary.
2. A single short press of the reverse 'Skip/Scan' button will take you to the beginning of the previous track.

LOCATING A SPECIFIC TRACK WHEN PLAYBACK IS STOPPED

1. A single short press of the reverse 'Skip/Scan' and forward 'Skip/Scan' buttons will skip between tracks in their relative directions.
2. Press 'Play' to start playback from the selected track.

REPEATING DISCS AND TRACKS

1. Ensure that the disc is loaded.
2. To repeat a specific track, press the Repeat button on the remote. 'RPT ONE' will appear on the display. Press 'Play' and the selected track will now repeat until the function is turned off. Alternatively, press the Repeat button, select the chosen track using the numerical buttons on the remote control and press 'Play'.
3. Press the Repeat button twice on the remote control. 'RPT ALL' will appear on the display. Press 'Play'. The whole disc will now be repeated until the function is turned off.
4. To turn the Repeat function off, press the Repeat button either before or during playback until 'RPT OFF' appear on the display.

PLAYING TRACKS IN RANDOM ORDER

1. Ensure that a disc is loaded.
2. Press the Random button on the remote control. 'RAN ON' will appear on the display.
3. Press 'Play'. The CD player will now play the entire disc in random order. It is also possible to press the Random button during playback to listen to tracks in random order.
4. Press the Random button to exit. The disc will continue playing to the end in the correct order.
5. Press the 'Stop' button at any time to stop the disc.

Note: Selecting 'Random' mode when 'RPT ONE' has been selected will automatically cancel 'RPT ONE' mode.

USING THE REMAIN FUNCTION

1. Ensure that the disc is playing.
2. Press the Remain button on the remote control once to display the time remaining for the track playing.

3. Pressing the Remain button the second time will show the total remaining disc time.
4. Press the Remain button again either before or during playback to return to normal play mode.

PROGRAMMING DISC PLAY

It is possible to program the AXC35/AXC25 to play back in any order only the tracks you wish to listen to.

1. Ensure that a disc is loaded. The display should show the TOC data.
2. Press the 'Prog' button on the remote control. The Program set-up will appear on the display.
3. Use the reverse 'Skip/Scan' and forward 'Skip/Scan' buttons or enter the track number that you want to program as your first track.
4. Press the 'Prog' button on the remote. The desired track is now programmed. The program number automatically increases by one for the next entry.
5. Repeat steps three and four until all your desired tracks are entered. A maximum of 20 tracks can be programmed.
6. Press the 'Play' button to begin programmed playback.
7. Press the 'Prog Clear' button on the remote to clear all programmed tracks.

Troubleshooting

Last updated: July 29, 2022 10:27. Revision #7160

There is no power

- Ensure that the AC power cord is connected securely.
- Ensure the plug is fully inserted into the wall socket and is switched on.

The player will not read the disc

- Check the disc is not loaded upside down.
- Check that the disc is not too scratched or dirty.
- Check that the disc type is compatible with the AXC25/35. (Check the 'Operating Instructions' section of the manual.)

There is no sound

- Ensure that the amplifier is set correctly.
- Check that the interconnects are inserted correctly.

The disc is skipping.

- Check that the disc is not too scratched or dirty.
- Ensure the player is on a firm surface and not subject to vibrations.

The remote will not function.

- Check that the batteries have not expired.
- Ensure that nothing is blocking the remote sensor.
- Ensure that you are not attempting to control the AXC with the 'AXA35 Only' functions on the remote. (Check the 'Remote Control' section of the manual.)

Technical specifications

Last updated: October 14, 2022 03:59. Revision #7159

AXC25:

D/A Converter:

Wolfson Microelectronics WM8524

Filter:

2 -pole Butterworth filter

Frequency response (+/-0.4dB):

20Hz - 20kHz

THD @ 1Khz 0dBfs:

<0.006%

THD @ 1Khz -10dBfs:

<0.015%

S/N ratio, A weighted:

> 93dB

Crosstalk @1kHz:

<-95dB

Crosstalk @20kHz:

<-95dB

Output impedance:

<50 ohms

Gapless Playback:

Yes

Maximum power consumption:

15W

Standby power consumption:

<0.5W

Dimensions:

75 x 430 x 305mm (3.0 x 16.9 x 12.2")

Weight:

4.3kg (9.5lbs)

AXC35:**D/A Converter:**

Wolfson Microelectronics WM8524

Filter:

2 -pole Butterworth filter

Frequency response (+/-0.4dB):

20Hz - 20kHz

THD @ 1Khz 0dBFs:

<0.006%

THD @ 1Khz -10dBFs:

<0.01%

S/N ratio, A weighted:

> 95dB

Crosstalk @1kHz:

<-98dB

Crosstalk @20kHz:

<-95dB

Output impedance:

<50 ohms

S/PDIF output impedance:

<75 ohms

Gapless Playback:

Yes

Maximum power consumption:

15W

Standby power consumption:

<0.5W

Dimensions:

75 x 430 x 305mm (3.0 x 16.9 x 12.2")

Weight:

4.3kg (9.5lbs)

Frequently Asked Questions (FAQ)

Last updated: July 29, 2022 10:27. Revision #7168

What is the difference between the AXC25 and AXC35?

The AXC35 contains an S/P DIF digital output. This offers extra flexibility as you can connect the AXC35 to an external DAC for improved sound quality.

Does the AXC25/35 support gapless playback?

Yes, the AXC25/35 does support gapless playback.

Does the AXC25/35 have its own volume control?

The AXC25/35 does not have a volume control of its own. The analogue and digital output (AXC35 only) are both line level.

You will need to control the volume via your connected amplifier or DAC.