

GOLD SERIES

o w n e r s m a n u a l

Contents

Introduction	2
Main Features	2
Unpacking	3
Plinth Fixing	3
Spikes and Feet	4
For Wooden/Hard Floors	4
For Carpeted Floors	4
Grilles	4
Setting Up	5
2 Channel Positioning	5
AV Positioning	5
Setting up the Gold FX	6
Fixing the Gold FX to a wall	8
Connecting Speaker Cables	9
Bare Wire Connection	9
Banana Plugs	9
Wiring	9
Single Wiring	9
Bi-Wiring	10
Bi-Amping	10
The Effects of Bi-Wiring/ Bi-Amping	10
Port bungs	11
Specifications	12
Owner Information	13

Introduction

Born from the incredible success of the award winning GX Range, the new Gold Series further fine tunes its distinguished qualities featuring new advanced driver technologies and materials amalgamated to form a real world, yet truly esoteric speaker range. The Gold Series focuses on sonic clarity, detail and conveying a truly honest expression of a recorded piece. Whether it be the epic cinematic soundscapes presented in a movie, or the soaring vocal melodies carried out by your favourite musical artist, the Gold Series will place you in the moment as if you were there.

This astounding attention to detail is not only evident the sound of the new Gold but in every component part, manufactured from only the finest materials and machined to exacting tolerances.

Main Features

- C-CAM® Ribbon transducer design – providing extension to a class leading 60kHz.
- New 5.5" and 6.5" bass drivers with C-CAM® cone – larger piston area offering higher efficiency and better dynamics.
- New 4" dedicated mid-range driver with C-CAM® cone and under-hung voice coil for very low distortion.
- New RST® Cone profile, for improved diaphragm rigidity and reduction in distortion.
- Die-cast Alloy chassis design for amazing rigidity and lower reflection properties.
- HiVe® port technology offers for smoother air-flow for a superior transient response and tighter bass.
- Single bolt through driver systems, for increased overall bracing, rigidity and driver/baffle de-coupling.
- Die-cast alloy terminal panel arrangement with high quality bi-wire terminals and high end spade type, Pureflow® Silver link cables.
- Pureflow® Silver internal cabling.
- High quality crossovers with premium grade Polypropylene film capacitors used throughout.
- Large radius cabinet edges provide low diffraction and smoother overall frequency response.
- Curved cabinet profile for increased rigidity and reduced internal standing waves.
- Hand selected premium quality wood veneer (dark walnut) or high gloss piano finishes (black, white or ebony).
- Rigid 20mm MDF construction throughout, employing both radial and cross-bracing techniques for high rigidity and ensuring low cabinet colouration.
- Invisible magnetic grille fixing offers clean visual styling when used without the grille.
- Full 3-way design (Gold 200, 300 & Gold C350).
- Die-cast alloy plinth structures and adjustable feet with provision for both hard and carpet floors (Gold 200 and 300 only).

Unpacking

Ensure there is plenty of clean floor area around where you are proposing to unpack the loudspeakers. Remove any loose components from the packaging (feet, bolts, plinths, grilles etc) and invert the carton. Lift the carton up and remove the packaging end cap. Remove the tape from the bag(s) revealing the bottom of the cabinet(s).

With the Gold 50 and Gold 100, stand the cabinets upright and remove the remaining packaging end cap and bag(s). Place the cabinets on the stands and position them according to instructions on page 5.

With the Gold 200 and Gold 300, fit the plinths and feet before proceeding any further.

Plinth Fixing

(Gold 200 & 300 only)

Fit the plinths and spiked feet to the base of each speaker. Refer to page 4.

The plinths are provided for stability as well as improving the acoustic performance of the speakers. Due to the tapered shape of the cabinets, it is not recommended to install them without the plinths fitted as the speakers are likely to be unstable.

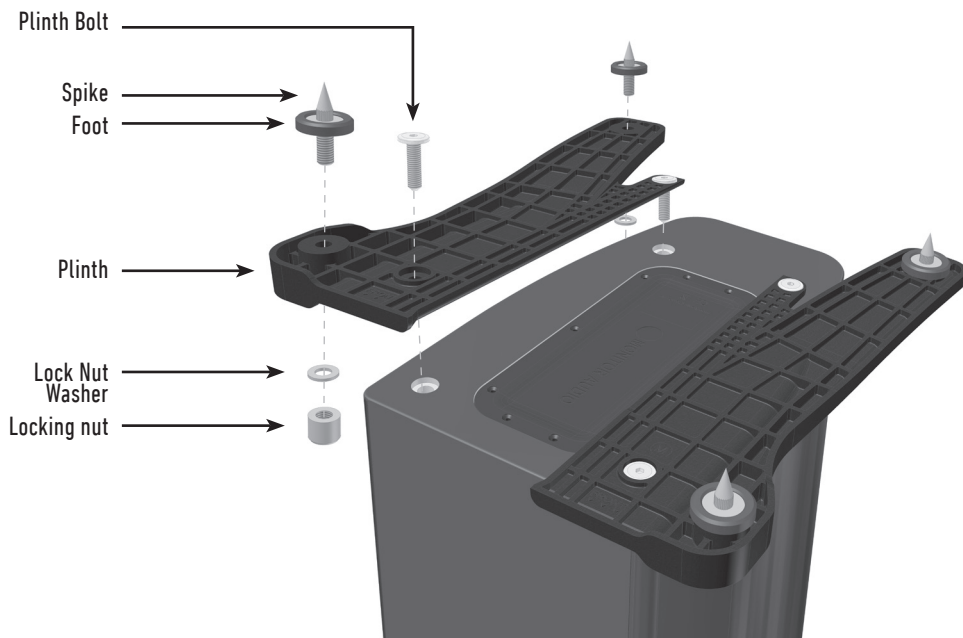

Spikes and Feet

For Wooden/Hard Floors

(Gold 200 & 300 only)

The foot comes pre-assembled for use on hard/solid floors or where spikes are inappropriate. All that is required is fixing them into the plinths. This is achieved by screwing the feet fully into the 2 threaded holes in each half of the plinth.

With great care turn the cabinet the right way up. Place the cabinet in the desired location, checking that it is level on all sides. If slightly off-level, unscrew the foot at the lowest point and check again. Continue this process until the cabinet is fully level. Use the locking nuts (illustrated on page 3) on each foot to fix the feet in place and to stop any unwanted vibrations.



For Carpeted Floors

(Gold 200 & 300 only)

If being installed on carpeted floors, remove the spike from the packaging and fix it into the foot assembly, as illustrated.

Please ensure there are no hidden wires under the carpet that could be damaged by the spikes.

With great care turn the cabinet the right way up. Place the cabinet in the desired location, checking that it is level on all sides. If slightly off-level, unscrew the foot at the lowest point and check again. Continue this process until the cabinet is fully level. Use the locking nuts (illustrated on page 3) on each foot to fix the feet in place and to stop any unwanted vibrations.

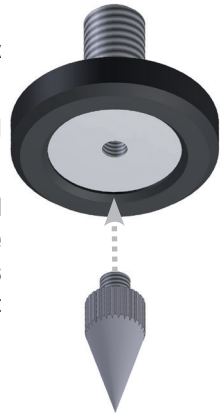

Grilles

The grilles are held invisibly in place by magnets in the cabinet itself (except Gold FX).

When fitting, firstly ensure they are the correct orientation (badge at the bottom) and offer them up to the cabinet. The magnets should then pull them into position, but it may need some fine adjustment to ensure they are square on the cabinet.

The Gold FX comes with the grilles factory fitted. When removing them, carefully prise them away from the cabinet with the tips of your fingers. There are three separate grilles fitted to each Gold FX cabinet.



CAUTION: Always remove the grilles before attempting to move or lift the loudspeakers.

Setting Up

2 Channel Positioning

When arranging a 2 channel system, the listening position and the loudspeakers should form an equilateral triangle. The speakers should be positioned approximately 6 - 10 feet (1.8 - 3m) apart. The ideal distance from the rear wall varies depending on the speaker (see list below), however, they need to be a minimum of 3 feet (91cm) from the side walls.

- Gold 50 and Gold 100 8 - 18 inches (20 - 45cm)
- Gold 200 18 - 24 inches (45 - 60cm)
- Gold 300 upto 36 inches (91cm)

Experimentation is strongly advised when initially setting up the speakers, as environment and personal preference differ with every installation. If there is insufficient bass for example, try moving your speakers closer to a wall. The opposite approach is recommended if there is excess bass. Also see the information on page 11 referring to Port Bungs. If stereo imaging is being lost, try 'toeing' them in slightly. The sound should appear to originate from the centre point between the speakers, not the actual speakers themselves.

AV Positioning

On pages 7 and 8, there are illustrations showing optimal positioning and some example room layouts for AV applications.

The front, and in some cases rear, floor standing and stand mount speakers should be positioned approx 6 - 9 feet apart (1.8m - 2.5m) and start with them about 10 inches (25cm) from the wall.

If the sound is too bass heavy or there is bass boom from the room when playing music (without a subwoofer), try moving the loudspeakers slightly further away from the wall(s) or adjusting the crossover frequency settings for the speakers and/ or sub. Also try changing the subwoofer's position. If this is not possible, then try the supplied port bungs (not included in the Gold FX or Centre). Refer to Page 11.

The Gold Centre channel should be positioned so they are pointing at the viewing position and at approximate ear height. If it is below or above ear height, use some rubber feet (small feet supplied) to angle it slightly.

The Gold FX's should be positioned in accordance with the below illustrations and instructions, and approx 2 feet (60cm) to the bottom of the speaker above ear height when in your listening position.



NOTE: When using 2 pairs of Gold FX in a 7.1 system, set the rear surround left speaker to 'Right' and the rear surround right to 'Left'. This is required due to tweeter phasing. All four speakers need to be set to di-pole mode.

Setting up the Gold FX

The Gold FX's are independent speakers that can be tailored to be either left or right handed at the flick of a switch. Likewise, they can be operated in either di-pole or mono-pole modes. The default factory setting is mono-pole.

In mono-pole mode, only the main driver and tweeter will be active. In di-pole mode, the main tweeter is disengaged and the side drivers and tweeters are active. The front firing tweeters are out of phase with the other tweeter and mid/bass unit. It is recommended to implement this configuration when using two pairs Gold FX as part of a 7.1 channel system, with the Gold FX's taking up positions on side and rear walls. Please note, it is essential they are positioned correctly when used in a 7.1 channel system. Please refer to the switch positioning images on pages 7 and 8.



NOTE: Before adjusting any switches, please ensure that the amplifier is at the very least turned off. This will help to protect the amplifier.

Tweeter Attenuation Switch: This switch adjusts the level of the main high frequency tweeter unit. In the middle position, there is no attenuation. Placed in the '-' position, the high frequencies will be attenuated by 3dB. Placed in the '+' position, the high frequencies will be boosted by 3dB.

Location Switch: This switch is used when determining the location of the Gold FX's. Please refer to the illustrations on pages 7 & 8 for correct positioning. This will only make a difference when in 'di-pole' mode.

Mono-pole/ Di-pole Switch: This switch determines the actual mode of the Gold FX. When part of 5.1 systems as a rear speaker, set the switch to mono-pole. Although there is nothing wrong with experimenting and trying the switch in the di-pole mode. If part of a 7.1 system as side speakers, set the switch to di-pole. If using 4 Gold FX's (side and rear) set them all to di-pole mode. Please see the illustrations on pages 7 & 8 to determine the setting of the 'Location Switch' depending on system set up.

If you are using the 12v trigger, set the switch to monopole mode. The trigger will switch a relay to enable the di-pole mode.

12 volt Trigger: (Not shown) This feature is present on some AV amplifiers. It is possible to customise the 12v trigger to switch the speakers to di-pole for certain sources. For example, multi-channel music should be listened to in mono-pole mode, however, movies should be listened to in di-pole mode. This feature automates the switching between the two modes. Please refer to your AV amplifier manual for further instruction.

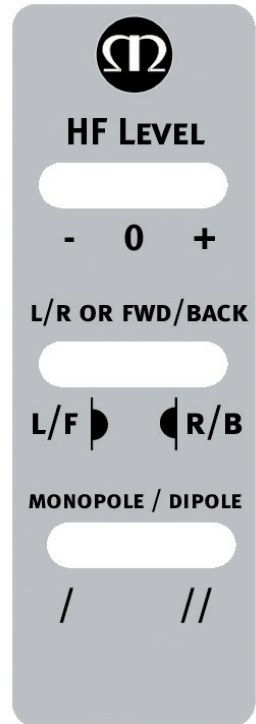

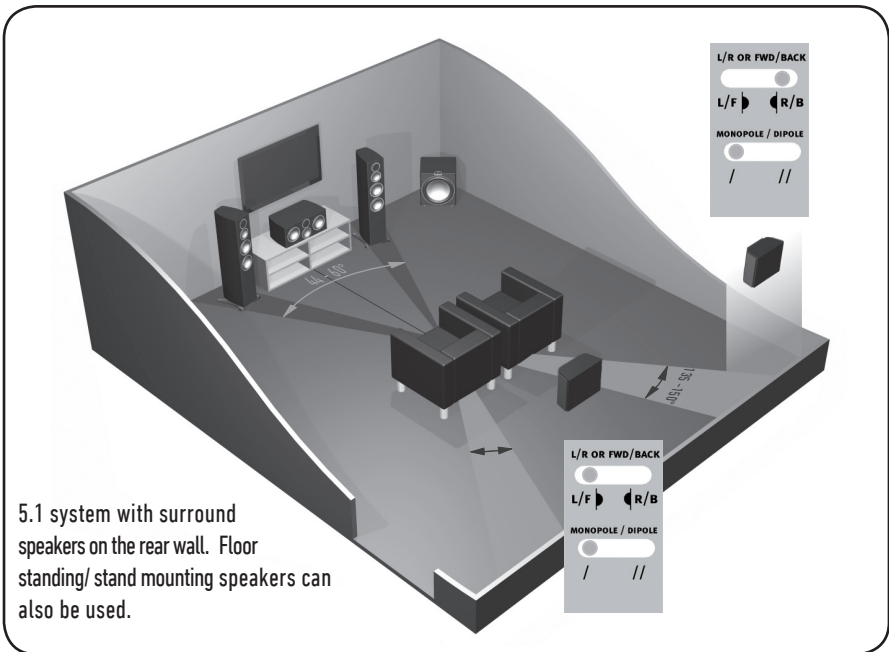

5.1 system with surround speakers on the rear wall. Floor standing/ stand mounting speakers can also be used.

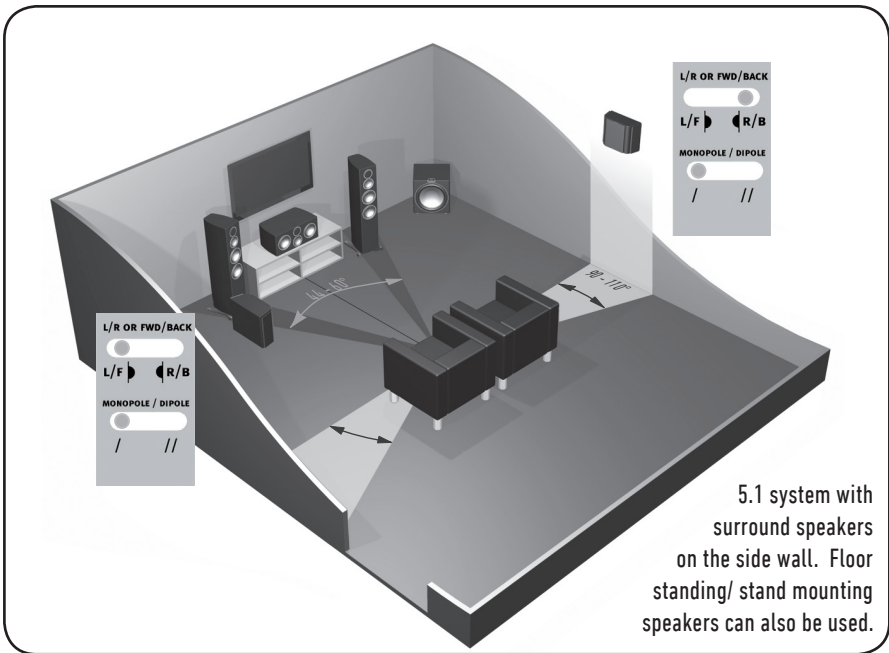

5.1 system with surround speakers on the side wall. Floor standing/ stand mounting speakers can also be used.

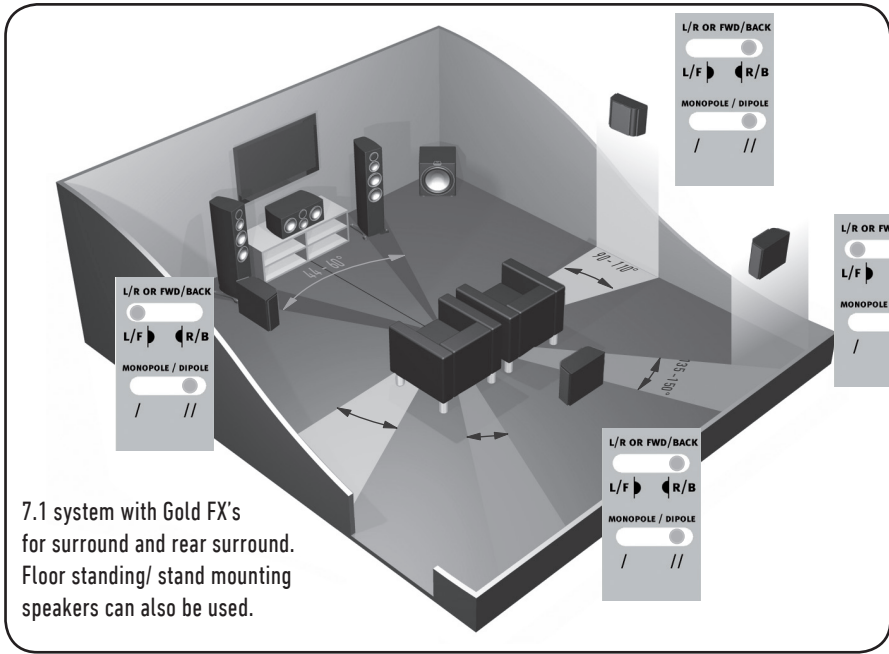

Fixing the Gold FX to a wall



CAUTION: Always determine where the Gold FX will be fixed and the structure of the wall. For safety reasons, if unsure of your ability to provide a secure and safe fixing, do not attempt to fix these speakers to a wall. Instead, please obtain the services of a competent and qualified trades person.



CAUTION: Ensure that water pipes or electricity cables do not run behind where the wall plate is going to be secured. Work from secure steps and avoid trailing wires.



NOTE: We do not supply wall fixing screws and plugs with the Gold FX. Please only use suitable fixings for the type of wall construction the Gold FX's will be fixed to.

To fix the Gold FX's to a wall, we would recommend using the wall fixing template provided within the packaging carton. Fix the wall plate to the wall, connect the speaker cables, and 12v trigger cables (if being used) and hang the cabinet on the wall plate.

Connecting Speaker Cables

Bare Wire Connection

Unscrew the binding posts and pass the bare wire through the through-hole. Tighten the binding post to clamp the wire in place.

Banana Plugs

Remove the red and black plastic plugs from the terminals and insert the banana plugs into the standard 4mm holes that are revealed. Pliers may be required to gain purchase on the plugs.



Wiring

Single Wiring

Single wiring is achieved via a single set of cables to the terminals on the back of the loudspeaker. Internally the loudspeaker crossover guides the frequencies to the appropriate driver/tweeter. Low frequencies to the bass drivers, mid frequencies to the mid/bass drivers and high frequencies to the tweeter.

It is perfectly acceptable to connect to the top, bottom terminals or even diagonally (experimentation is advisable to achieve the preferred results).



NOTE: When using this method you must KEEP the terminal links in place.

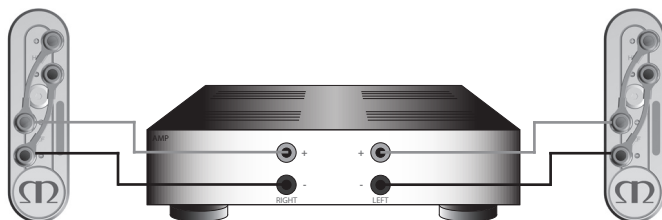

Bi-Wiring

Bi-wiring is accomplished by connecting separate pairs of speaker cables to the terminals on the loudspeaker from a single pair of connections on the amplifier. In the case of the Gold Series, the bottom terminals connect to the bass driver(s) and the top terminals connect to the tweeter in 2 way loudspeakers, or the mid and tweeter in 2.5 and 3 way loudspeakers.



NOTE: When using this method the terminal links MUST be removed.



Bi-Amping

Bi-Amping is the same as Bi-Wiring except you are introducing a second amplifier into the equation.

In order to Bi-Amp you must connect a set of speaker cables to the top terminals on the loudspeaker from one amplifier and another set of speaker cables to the bottom terminals from the second amplifier.



NOTE: When wiring this method the terminal links MUST be removed.



The Effects of Bi-Wiring/ Bi-Amping

Fundamentally a loudspeaker crossover varies the impedance seen by the speaker and by the power amplifier. The situation is such that when the full range musical signal is applied to the terminals of a full-range speaker system, the bass driver(s) only receives low frequency signals, the mid driver receives the mid band frequency signals and the tweeter only gets sent high frequency signals. This means that if separate speaker cables are connected to the low frequency terminals, and the high frequency terminals, not only have the drive units and the frequency's directed and divided for them, but the two separate speaker cables will now also carry different signals, the bass cable mostly the lows, and the tweeter cable mostly the highs.

Once the high and low frequencies have been separated in this fashion, the strong current pulses and surges demanded by bass drivers when reproducing bass or drums, will not interact with the delicate sounds of a flute or cymbal.

In a single wired system, unwanted mechanical and electrical resonances manifest as distortion at both sets of speaker terminals. Due to the impedance of the speaker cables, these distortions will not be entirely cancelled by the amplifier. Instead, they modulate between the two crossovers, and degrade sound quality. When bi-wiring, this interaction is minimised as signal distortion is 'seen' at the amplifier's output where it can be more effectively cancelled. Bi-wiring/ bi-amping therefore presents a 'cleaner' signal at both the low frequency and high frequency speaker terminals, and because the high and low frequencies have already been separated, each has a minimal effect on the other - in essence the bass does not overpower delicate treble.

In terms of the audible benefit, bi-wiring/ bi-amping, provides more clarity and detail to the midrange and high frequencies. Often the bass will become faster and tighter. Focus and staging will improve as well. In all, this is a very effective and desirable improvement and is highly recommended by Monitor Audio.

Port bungs



WARNING: Care must be taken not to insert the port bungs too far into the port, as this may result in the foam bung being lost inside the cabinet.

If the loudspeaker is to be installed in a small room, typically 9 sqM (80 sqFT), or a room known to reproduce accentuated bass response, it may be desirable to fit port bungs. However, experimentation is recommended with positioning of the loudspeaker in the room prior to fitting. To optimise performance from the loudspeaker it is important to ensure the loudspeaker is not positioned too close to a wall or near the corners of a room (refer to the suggestions on page 5).

If the positioning of the loudspeaker is predetermined by room aesthetics or layout, or you find you have accentuated bass, please move on and read point 1 for the Gold 50/ Gold 100 and point 2 for the Gold 200/ Gold 300.

1. Where stand-mount speakers (Gold 50 & Gold 100) are to be sited in close proximity (less than 8 inches/ 20cm) to a rear wall (such as on a bookshelf, positioned in a cabinet or on a stand close to a wall), we recommend fitting port bungs to the ports. This will reduce the bass 'boom' sometimes termed as overhang, and assist the loudspeakers to reproduce their best performance under these environmental conditions. 'Boom' is generally caused when bass energy from the loudspeaker 'excites' room modes and causes an accentuation at a particular frequency, or number of frequencies.
2. Where floor-standing loudspeakers (Gold 200 & Gold 300) are to be sited in close proximity (closer than 18 inches/ 45cm) to a rear wall, we recommend fitting the port bungs. This will reduce the bass 'boom' sometimes termed as overhang and assist the loudspeakers to reproduce their best performance under these environmental conditions. This is caused when bass energy from the loudspeaker 'excites' room modes and causes an accentuation at a particular frequency, or number of frequencies.

When fitting port bungs the overall bass extension will not be reduced, however bass energy/ output around the port tuning frequency will be reduced. This has the effect of reducing bass 'boom' while increasing bass clarity and apparent agility.

In all circumstances experimentation is highly recommended.

	Gold 50	Gold 100	Gold 200	Gold 300	Gold C150	Gold C350	Gold FX
System Format	2 Way	2 Way	3 Way	3 Way	2 Way	3 Way	2 Way
Frequency Response	55Hz – 60kHz	42Hz – 60kHz	35Hz – 60kHz	30Hz – 60kHz	55Hz – 60kHz	40Hz – 60kHz	60Hz – 60kHz
Sensitivity (dB)	86	88	89	90	89	90	87
1W@1m							
Nominal Impedance (ohms)	8	8	8	8	8	8	8
Maximum SPL (dBA)	109.8	112.6	114.5	116.8	111.5	113.8	110.8
Power Handling - RMS (W)	100	120	150	200	150	200	100
Recommended Amplifier Requirements (W)	50 - 100	60 - 120	100 - 150	100 - 200	100 - 150	100 - 200	50 - 100
Bass Alignment	Bass Reflex, Hive® port system	Bass Reflex, Hive® port system	Bass Reflex, Hive® port system	Bass Reflex, Hive® port system	Sealed Cabinet	Sealed Cabinet	Sealed Cabinet
Crossover Frequency	2.3kHz	2.7kHz	LF - M.F.: 400Hz M.F - H.F.: 2.6kHz	LF - M.F.: 790Hz M.F - H.F.: 2.3kHz	2.8kHz	LF - M.F.: 800Hz M.F - H.F.: 2.3kHz	Bi-Pole: 2.3kHz Di-pole: 2.6kHz
Drive Unit Complement	1 x 5.5" RST® bass / mid driver 1 x C-CAM® ribbon H.F. transducer	1 x 6.5" RST® bass / mid driver 1 x C-CAM® ribbon H.F. transducer	2 x 5.5" RST® bass driver 1 x 4" RST® mid-range driver 1 x C-CAM® ribbon H.F. transducer	2 x 6.5" RST® bass driver 1 x 4" RST® mid-range driver 1 x C-CAM® ribbon H.F. transducer	2 x 5.5" RST® bass driver 1 x C-CAM® ribbon H.F. transducer	2 x 6.5" RST® bass driver 1 x 4" RST® mid-range driver 1 x C-CAM® ribbon H.F. transducer	1 x 6.5" RST® bass driver 2 x 4" C-CAM® mid-range driver 1 x C-CAM® ribbon H.F. transducer 2 x 25mm Gold C-CAM® dome tweeter
Cabinet Dimensions H x W x D mm (inches)	300 x 170 x 263 11 13/16 x 6 11/16 x 10 3/8	362 x 210 x 303 14 3/8 x 8 1/4 x 11 13/16	951 x 170 x 300 37 7/16 x 6 11/16 x 11 13/16	1060 x 210 x 330 41 3/8 x 8 1/4 x 13	172 x 461 x 303 6 11/16 x 18 1/8 x 11 15/16	254 x 581 x 333 10 x 22 7/8 x 13 1/8	310 x 390 x 160 12 3/16 x 15 3/8 x 6 5/16
Complete Dimensions Inc Terminals, Plinths & Spikes H x W x D mm (inches)	300 x 170 x 290 11 13/16 x 6 11/16 x 11 7/16	362 x 210 x 330 14 3/8 x 8 1/4 x 13	995 x 274 x 370 39 7/16 x 10 13/16 x 14 9/16	1105 x 317 x 370 43 1/2 x 12 1/2 x 14 9/16	172 x 461 x 330 6 11/16 x 18 1/8 x 13	254 x 581 x 360 10 x 22 7/8 x 14 3/16	310 x 390 x 168 12 3/16 x 15 3/8 x 6 5/8
Product Weight (kg (lbs))	7.5 (16lb 8oz)	9.9 (21lb 12oz)	22.2 (48lb 14oz)	27.2 (59lb 14oz)	6 (13lb 4 oz)	19.6kg (43lb 2oz)	11.9 (26lb 2oz)

Owner Information

Product Details

Model _____

Product Serial No _____

Date of Purchase _____

Dealer Details

Dealer Name _____

Address _____

e-mail address _____

Telephone Number _____

Monitor Audio reserves the right to alter specifications without notice.

For the 5 years manufacturer's warranty, please visit the online registration form at:
www.monitoraudio.com



Monitor Audio Ltd.

24 Brook Road

Rayleigh, Essex

SS6 7XJ

England

Tel: +44 (0)1268 740580

Fax: +44 (0)1268 740589

Email: info@monitoraudio.co.uk

Web: www.monitoraudio.com

**Designed and Engineered
in the United Kingdom
Made in China**

© 2014. Version 1