

EVO CD

Manual Generated: 17/10/2023 - 08:10

Table of Contents

EVO CD	3
Introduction	4
What's included with the EVO CD?	5
Front panel controls	6
Rear panel connections	7
Remote Control	8
Getting connected	9
Operating instructions	10
Replaceable side panel	13
Troubleshooting	14
Technical specifications	15
Frequently Asked Questions (FAQ)	16

EVO CD

Last updated: May 16, 2023 05:58. Revision #9421

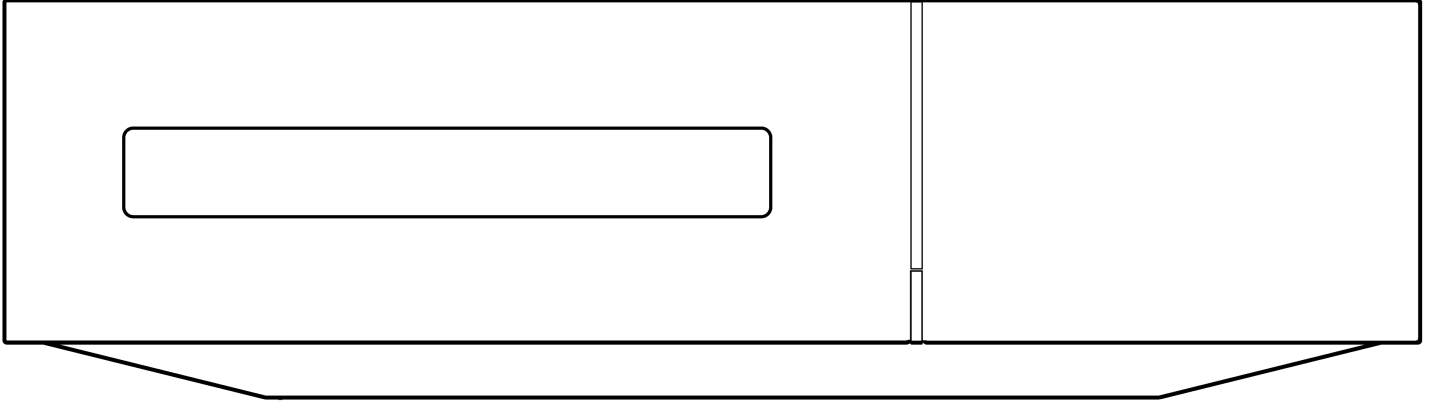

Users Manual

Introduction

Last updated: May 16, 2023 05:58. Revision #9422

This guide is designed to make installing and using this product as easy as possible. Information in this document has been carefully checked for accuracy at the time of publishing; however, Cambridge Audio's policy is one of continuous improvement, therefore design and specifications are subject to change without prior notice.

This document contains proprietary information protected by copyright. All rights are reserved. No part of this manual may be reproduced by any mechanical, electronic or other means, in any form, without prior written permission of the manufacturer. All trademarks and registered trademarks are the property of their respective owners.

© Copyright Cambridge Audio Ltd 2023

For upcoming news on future products, software updates and exclusive offers, make sure you register your product at <https://www.cambridgeaudio.com/register>

What's included with the EVO CD?

Last updated: May 16, 2023 05:58. Revision #9423

Inside the box of your EVO CD you will receive:

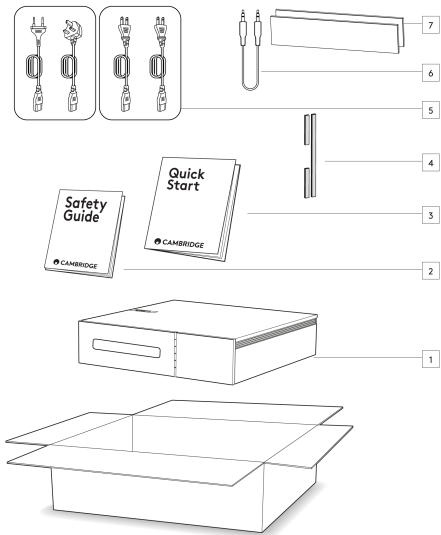

1. EVO CD
2. Safety guide
3. Quick start guide
4. Extra Feet for EVO 75/150
5. UK mains lead (Depending on which country the EVO CD was bought).
- EU mains lead (Depending on which country the EVO CD was bought).
- CU mains lead (Depending on which country the EVO CD was bought).
6. Evo dedicated connection cable
7. Side panels x2

Front panel controls

Last updated: May 16, 2023 05:58. Revision #9424

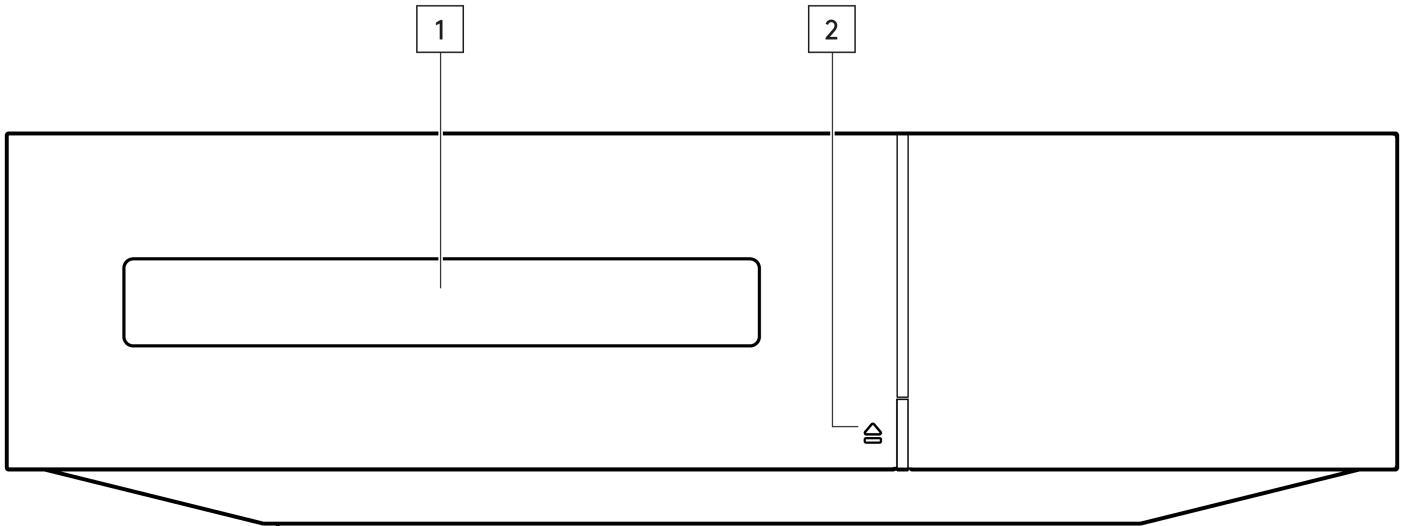

1. **Disc tray** - Used for the loading of compact discs, operated by the Open/Close button.
2. **Open/Close** - Allows you to open and close the disc tray. After placing a CD in the tray, press Open/Close to close the tray.

Rear panel connections

Last updated: May 16, 2023 05:58. Revision #9425

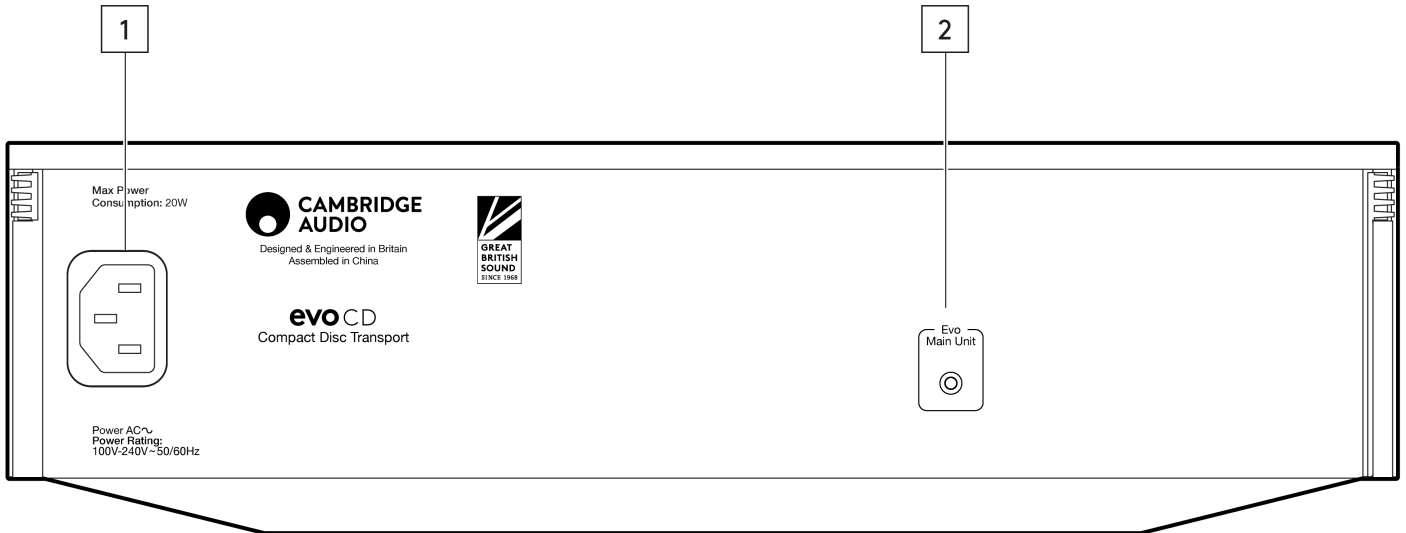

1. **AC Power socket** - Once you have completed all connections to the EVO CD, plug the supplied AC power cable into an appropriate mains socket then switch on. Your EVO CD is now ready for use.

2. **EVO Main Unit output** - A dedicated connection from an EVO 75/150. Connect the supplied connection cable from this output to the CD input on your EVO 75/150.

Note: This output can only be connected to the EVO 75/150 and is not able to be used with another device.

Remote Control

Last updated: May 16, 2023 05:58. Revision #9426

Note: The EVO CD does not come with a remote control included. Please use the EVO remote control that is supplied with the EVO 75/150.

1. Mute (EVO 75/150 only)
2. Standby/On (EVO 75/150 only)
3. Preset buttons (EVO 75/150 only)
4. Speaker output (EVO 75/150 only)
5. Info (EVO 75/150 only)
6. Brightness (EVO 75/150 only)
7. **Eject CD (EVO CD only)** - Press to eject the CD from the disc tray.
8. **Stop (EVO CD only)** - Press to stop playback.
9. **Play/Pause/Skip** - Press the Play/Pause button to play or pause playback. Press the Skip buttons to skip tracks in the desired direction.
10. Source selection (EVO 75/150 only)
11. Volume (EVO 75/150 only)

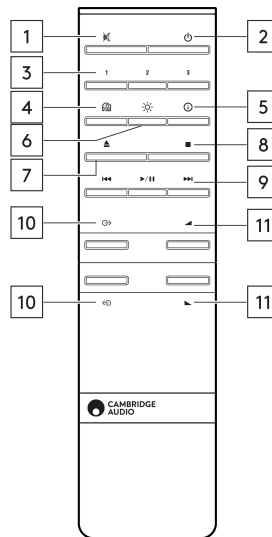

If the remote control will not function, please check that the batteries have not expired, and that there is nothing blocking the front panel IR sensor, which is located in the EVO 75/150. There is no IR sensor located in the EVO CD.

Getting connected

Last updated: May 16, 2023 05:59. Revision #9427

The diagram below shows the basic connection of the EVO CD to an EVO 150, using the supplied connection cable.

The EVO CD can only be connected to the EVO 75/150 and will not work with another device.

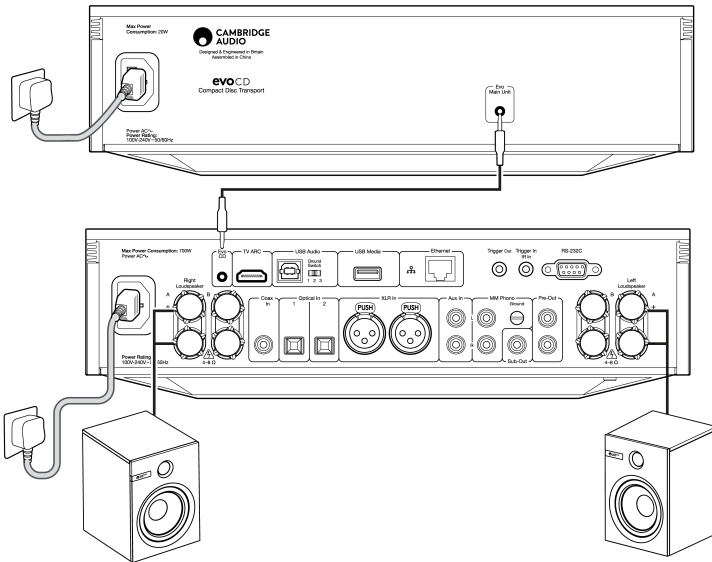

Note: We do not recommend placing the EVO CD right next to and touching your EVO 75/150, if you are placing the units side by side. The EVO 75/150 Wi-Fi and Bluetooth antennas are located in the sides of the unit, and another device touching this can reduce Wi-Fi and Bluetooth signal strength and effect connectivity.

Operating instructions

Last updated: May 16, 2023 05:59. Revision #9452

Notes:

- Your connected EVO 75/150 will need to be switched on and have the 'CD' source selected, in order to achieve audio playback from the EVO CD.
- Ensure that your EVO 75/150 is running the latest firmware version. Your EVO 75/150 will need to be running Service Pack version **v132-b-004** or later for the EVO CD to function.

The EVO CD has been designed to only play:

- Compact discs
- Recordable CDs (CD-R)
- Re-writable CDs (CD-RW) bearing the identification logo shown below.

Note: The CD-R/CD-RW discs should contain properly recorded TOC (Table of Contents) information so that they can be played back.



LOADING AND UNLOADING DISCS

1. Connect the EVO 75/150 to the EVO CD using the supplied EVO connection cable.
2. Turn on the EVO 75/150 and set the source selector to 'CD'.
3. Using the front panel of the EVO CD or remote control, press the "Open/Close" button to open the disc tray.
4. Once the disc tray has fully opened, carefully place a disc into the tray with the label side facing upwards.
5. Close the disc tray by pressing the "Open/Close" button again. When the tray has fully closed the EVO CD will read the disc and the EVO 75/150 will display the content information.
6. The disc tray can be opened at any time during playback using either the front panel "Open/Close" button, or the one located on the remote control. Only remove an inserted disc after the disc tray has fully opened.

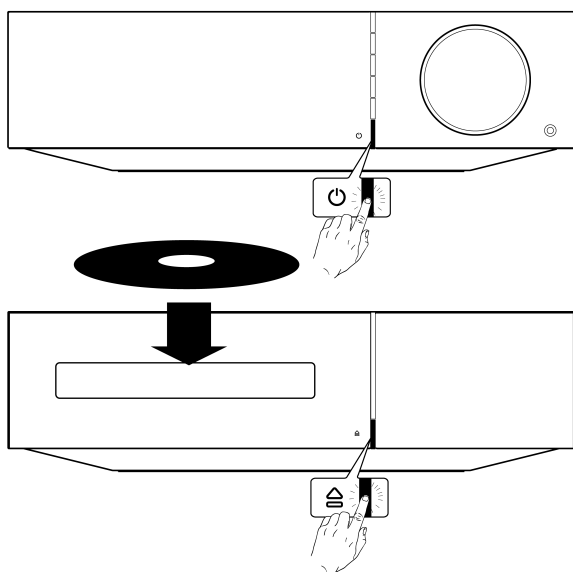

Important Information:

- Do not put anything except for a compact disc into the disc tray as this can damage the mechanism.
- Do not force the tray by hand during opening and closing operations.
- To avoid dirt and dust entering the mechanism, keep the disc tray closed when not in use.
- If the compact disc that you are attempting to load is badly scratched or dirty, the player may be unable to read or play it.
- Never attempt to load multiple discs into the disc tray at any time.

Normal Disc Play

1. Connect the EVO 75/150 to the EVO CD using the supplied EVO connection cable.
2. Turn on your EVO 75/150 and set the source selector to 'CD'. Adjust the volume control to a minimum.
3. Press the "Open/Close" button to open the disc tray and load a disc.
4. Press the "Open/Close" button again to close the tray. The EVO CD will read the disc.
5. To begin playback, press the Play button on the EVO 75/150 or the remote control.
6. When the last track has finished playing, the display will return to Table of Contents (TOC).
7. To stop the disc at any point, press the 'Stop' button on the remote control. To pause the disc, press the 'Play/pause' button on the EVO 75/150 front panel, remote control or StreamMagic app. Playback can then be resumed by pressing the 'Play' button again.

LOCATING A SPECIFIC TRACK DURING PLAYBACK

1. A single short press of the forward 'Skip/Scan' button on the EVO 75/150 front panel, remote control or StreamMagic app will take you to the beginning of the next track on the CD. Repeat as necessary.
2. A single short press of the reverse 'Skip/Scan' on the EVO 75/150 front panel, remote control or StreamMagic app button will take you to the

beginning of the previous track.

LOCATING A SPECIFIC TRACK WHEN PLAYBACK IS STOPPED

1. A single short press of the reverse 'Skip/Scan' and forward 'Skip/Scan' buttons on the EVO 75/150 front panel, remote control or StreamMagic app will skip between tracks in their relative directions.
2. Press 'Play' on the EVO 75/150 front panel, remote control or StreamMagic app to start playback from the selected track.

REPEATING DISCS AND TRACKS & PLAYING TRACKS IN RANDOM ORDER

For more functions, please download our StreamMagic app, please visit: <https://www.cambridgeaudio.com/gbr/en/products/streammagic>

Replaceable side panel

Last updated: May 16, 2023 05:59. Revision #9429

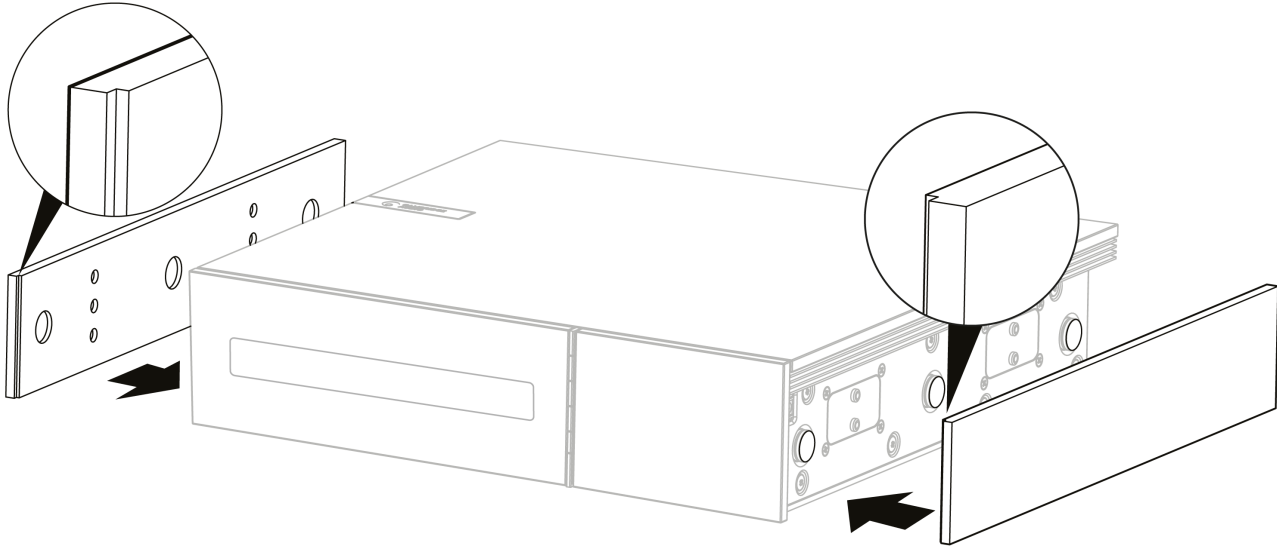

When installing new magnetic side panels, please ensure that the groove cuts are aligned with the direction of the front panel. Insert from the rear by holding the rear of the panel.

Important note: The magnets can snap hard and pinch your fingers if not done correctly.

Troubleshooting

Last updated: May 18, 2023 04:27. Revision #9453

There is no power

- Ensure that your EVO CD has been connected to your EVO 75/150 using the supplied connection cable.
- Ensure that your connected EVO 75/150 is running the latest firmware version.
- Ensure that your connected EVO 75/150 has been switched on, and the 'CD' source has been selected.
- Ensure that the AC power cord is connected securely.
- Ensure the plug is fully inserted into the wall socket and is switched on.
- Check fuse in the mains plug or adaptor.

The player will not read the disc

- Check the disc is not loaded upside down.
- Check that the disc is not too scratched or dirty.
- Ensure that the loaded disc type is compatible with the EVO CD.

There is no sound

- Ensure that your EVO CD has been connected to your EVO 75/150 using the supplied connection cable.
- Ensure that your connected EVO 75/150 has been switched on, and the 'CD' source has been selected.
- Check that the interconnects are inserted correctly.
- Check that the EVO 75/150 is not in mute mode.
- Ensure the speakers have been connected to the EVO 75/150 properly.
- Ensure that the correct speaker output has been selected via the EVO 75/150 (Speaker A, Speaker B, Speaker A+B, Bluetooth output).

The EVO 75/150 is not displaying the CD's album artwork or track data

- The EVO CD uses a music database called 'Music Brainz' to retrieve cover artwork and track information. If you are playing a CD that doesn't display its album artwork or data, this will be because the album/release is not in the Music Brainz database.

You can add an album/release to the Music Brainz database by firstly creating an account on the Music Brainz website [here](#), and then following the relevant steps via their 'How to contribute' page [here](#). You will be able to add an [artist](#), [album](#) or [song](#) to their database.

The disc is skipping

- Check that the disc is not too scratched or dirty.
- Ensure the player is on a firm surface and not subject to vibrations.

There is a hum coming from the speakers

- Ensure that all cable connections are secure.

The remote control will not function

- Check that the batteries have not expired.
- Ensure that nothing is blocking the IR sensor which is located in the EVO 75/150. There is no IR sensor located in the EVO CD
- If the EVO 75/150 and EVO CD are located away from each other, ensure you are pointing the remote control at the EVO 75/150.
- The EVO CD can only be controlled by the relevant 'EVO CD Only' buttons on the remote control.

For more frequently asked questions (FAQ's), technical advice and information on getting the most out of your EVO CD, please visit the Support section on Cambridge Audio's website: <https://casupport.cambridgeaudio.com/en/product/3556904-EVO-CD>

Technical specifications

Last updated: May 16, 2023 06:01. Revision #9431

Total correlated jitter:

<140pS

Maximum power consumption:

20W

Standby power consumption:

<0.5W

Servo:

Cambridge S5

Disc compatibility:

CD-DA, CD-R, CD-RW

Gapless playback:

Yes

Connection:

EVO Link

Dimensions (W x H x D):

317 x 89 x 352mm

Weight:

5Kg

Frequently Asked Questions (FAQ)

Last updated: May 16, 2023 06:01. Revision #9432

Can I connect the EVO CD to another amplifier or device?

The EVO CD was only designed to be connected to other products in the EVO range, and will only work with the EVO 75 / 150. It will not work with any other products, Cambridge Audio or otherwise.

Can I use another cable to connect my EVO CD to the EVO 75/150?

We only recommend using the supplied EVO connection cable when connecting your EVO CD to your EVO 75/150.

Why doesn't the EVO 75/150 display my CD's album artwork or track information?

The EVO CD uses a music database called 'Music Brainz' to retrieve cover artwork and track information. If you are playing a CD that doesn't display its album artwork or data, this will be because the album/release is not in the Music Brainz database.

You can add an album/release to the Music Brainz database by firstly creating an account on the Music Brainz website [here](#), and then following the relevant steps via their 'How to contribute' page [here](#). You will be able to add an [artist](#), [album](#) or [song](#) to their database.

The wooden side panels on my EVO CD and EVO 75/150 don't match.

The supplied wooden side panels are made from real wood. As no two pieces of wood are exactly the same, it is a likelihood that they may not exactly match the wooden side panels already on your EVO 75/150.

Can the EVO CD play SACDs or MP3/WMA discs?

It is not possible to play SACD, MP3 or WMA discs on the EVO CD. The EVO CD can play CD-DA, CD-R and CD-RW discs.

The EVO CD will play the CD layer of hybrid SACDs.

How do I check/update the firmware version of the EVO CD?

The firmware version of the EVO CD will always be the same as the firmware version of your connected EVO 75/150. As long as your EVO CD is connected to your EVO 75/150, the firmware of the EVO CD will automatically update in sync with the firmware of the EVO 75/150.

You can check/update the firmware version of your EVO 75/150 by following the 'Firmware' steps in the manual [here](#).

Does the EVO CD support gapless playback?

Yes, the EVO CD does support gapless playback.

Does the EVO CD have its own volume control?

The EVO CD does not have a volume control of its own. You will need to control the volume via your connected EVO 75/150.

Can the EVO CD play MQA CDs?

Yes, the EVO CD will be able to play MQA CDs.