

Atessa CD Transport

Owners Manual

ROKSAN

Contents

Contents	1	Operation	4
Introduction	1	OLED Display	4
Unpacking	1	Turning On & Standby	4
Warranty	1	Insert Disc	4
EU DIRECTIVES	2	Playing a Disc	5
AC MAINS SUPPLY	2	Options Menu	5
Maintenance	2	Updates	7
Location	2	Troubleshooting	8
Front Controls	3	Specifications	9
Rear Connections	3		
Remote	3		
Connections	4		
Signal	4		
Power	4		

Introduction

Congratulations on your purchase of the Roksan Attessa CD Transport. This CD transport is designed and manufactured to the highest specification and rigorously tested to reward you with many years of listening pleasure.

Your Attessa CD Transport is an integral part of your Hi-Fi system. Its correct installation, set-up and operation will have a significant influence on the performance of the entire Hi-Fi installation. Please read the contents of this manual thoroughly. It will help you to understand your Hi-Fi equipment better and further enhance your listening pleasure.

Unpacking

Included in the packing of your CD Transport you will find:

- Mains lead(s) fitted with the correct mains power plug for your country.
- One Attessa Remote Control and 2 x AAA batteries
- One high quality digital coaxial cable
- One information pack

After removing these items please retain all packing material and instruction manuals. Correct packing is necessary for future transportation of your CD Transport.

Warranty

Both the craftsmanship and the performance of this product is covered by the manufacturer's warranty against manufacturing defects provided that the product was supplied by an authorised Roksan retailer under the consumer sale agreement. For the period of cover please refer to the product page on our website: roksan.com for the product you have purchased.

When purchasing Roksan products, please keep your receipt of purchase safe, as this validates your warranty.

The words 'consumer sale' shall be construed in accordance with section 15 of the supply of goods act 1973. Roksan accepts no responsibility for defects arising from accident, misuse, abuse, wear and tear, modification or operation outside of that specified within this instruction manual. Neither will responsibility be accepted for damage or loss occurring during transit to or from the parties claiming under this guarantee.

This guarantee covers both labour and parts. The liability of Roksan is limited to the cost of repair or replacement of the defective parts (at the discretion of Roksan) and under no circumstances extends to consequential losses or damage.

EU DIRECTIVES



Roksan declares that the apparatus "Attesa CD Transport" complies with the essential requirements and other relevant provisions of Directive 1999/5/EC".



NOTE: This product must be earthed. Please ensure that other equipment connected to it is earthed according to the manufacturer's instructions.

AC MAINS SUPPLY

Your Attesa CD Transport is set to operate from a fixed supply voltage which is marked on a label next to the mains input plug. The mains lead supplied with this product has an IEC C13 mains plug which is inserted into the Mains Input Socket on the unit's rear panel. The other end is a moulded plug appropriate to that for your country.

This plug should ordinarily not be removed from the lead. If you do remove it, please dispose of it safely so that it cannot be plugged into a mains socket whilst in a potentially dangerous condition. If your lead has been damaged please obtain a complete replacement lead from your dealer.

Should you move to another area where either the mains voltage or the mains plugs are different from those as supplied with your CD transport, please contact the appointed Roksan distributor for assistance.



Please observe correct mains polarity at all times.

The mains fuses are located on the rear panel below the IEC Mains Input Socket. These must only be replaced by the fuse type and rating as described on the fuse rating label on the rear panel of the unit.

If the equipment is likely to be unused for some time, unplug it from the mains supply.

Maintenance

After disconnecting the CD Transport from the mains supply, the casing and front panel may be cleaned with a lightly dampened lint-free cloth. Furniture polish can also be used to clean the CD transport. Avoid using abrasive substances or solvents.

Location

Your CD Transport should be located in a well ventilated area and kept away from sources of heat, dust, humidity and direct sunlight.

The CD Transport may be positioned either as a free standing unit or alongside other audio/video product(s). Never place the CD Transport on other electronic equipment, carpet or any surface likely to hinder normal ventilation. Never allow liquids or other objects to fall into the unit.

When purchased with an Attesa Amplifier or Streamer, we recommend placing the CD Transport below the Amplifier or Streamer



NOTE: This unit contains no user serviceable parts. Do not remove any panels or attempt to service it yourself. **Unauthorised servicing will void the warranty.**

Front Controls

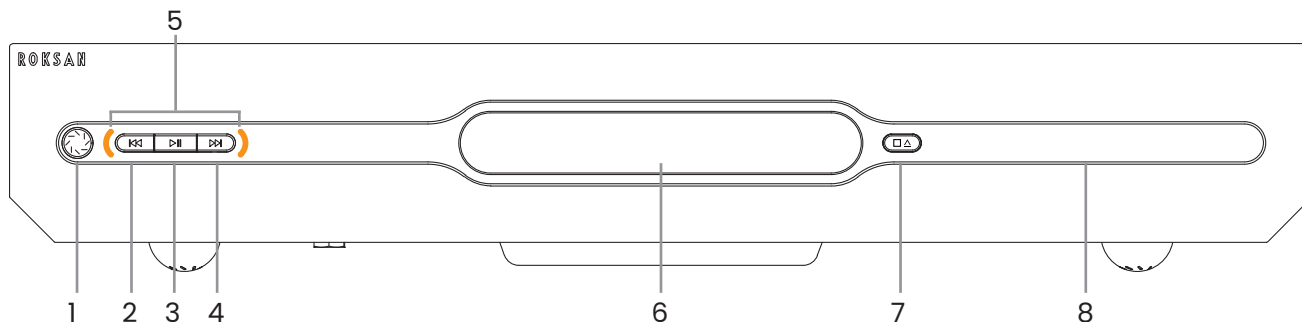

- | | |
|--------------------------|-----------------------------|
| 1. Standby Button | 5. Indicator LEDs |
| 2. Previous Track Button | 6. CD Drawer |
| 3. Play/Pause Button | 7. Open/Close & Stop Button |
| 4. Next Track Button | 8. OLED Display |

Rear Connections



- | | |
|-------------------|--------------------------------|
| 1. Digital Output | 2. Mains Input & Fuse Location |
|-------------------|--------------------------------|

Remote

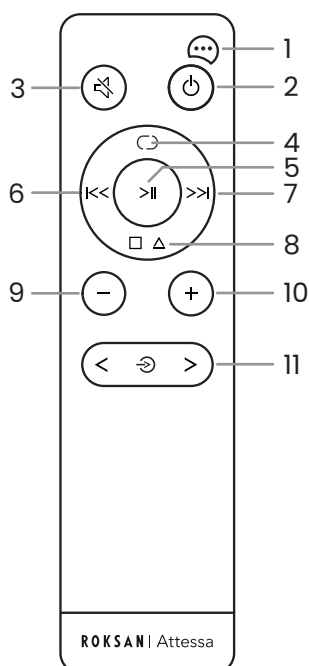

1. Settings Menu
2. Standby
3. Mute
4. Repeat All/ Repeat Track/ Shuffle
5. Play/ Pause
6. Previous/ Scan backwards
7. Next/ Scan forwards
8. Stop/ Open/ Close
9. Volume Down (Amplifiers only)
10. Volume Up (Amplifiers only)
11. Source Scroll Left & Right (Amplifiers only)

Connections

Signal

Connect the supplied digital coaxial cable to the output of the CD Transport and the other end to the digital coaxial input of your amplifier - D1 on the Attesa Integrated/ Streaming Amplifier is the default CD Transport Input.

Power

The moulded IEC plug of the supplied mains lead should be plugged into the socket on the rear of the unit first and then plugged into the mains supply.

The mains fuse is located here in the small drawer attached to the mains input socket. The fuse is a TIAL type.

Operation

OLED Display

To preserve the life of the OLED display, there is an automatic display saver mode.

If there are no commands received for 2 minutes the display will turn off until a command is received, except when a CD is playing when it will dim to half brightness after 10 - 15 seconds until the end of the CD or a command is received.

Turning On & Standby

A single press of the standby button on the unit or single press of the standby button on the remote will wake the unit from standby and the button LED will turn solid orange. The Roksan logo will also appear on the display to the right of the CD Drawer followed by "NO DISC" (when used for the first time or when the power is removed).

A single press of the Standby Button on the unit or single press of the Standby Button on the remote and logo will turn solid red and the display will go off and the unit will enter standby mode.

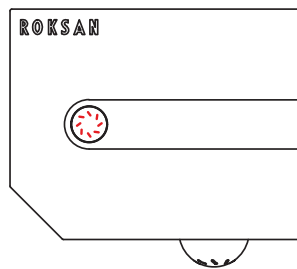

ROKSAN

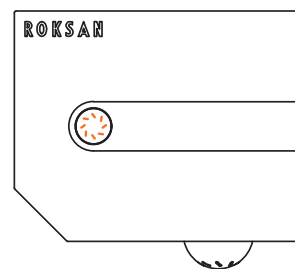

NO DISC

Insert Disc

When out of standby, a single press of the open/ close button on the unit or a single press of the stop/ open/ close button on the remote will open the CD drawer and the display will show "OPENING", then "OPEN".

OPENING

OPEN

Place the disk on the CD Drawer and press the open/ close button on the remote or unit and the drawer will close and the CD Transport will start to read the disk. Once read, the number of tracks and total time on the disk will be displayed.

READING

12 34:10

Playing a Disc

A single press of the Play/ Pause button on either the remote or the unit itself will start playback of the disc. Both indicator LEDs will flash to indicate the command has been received.

A second press will pause the current playback, the indicator LEDs will stay illuminated until the Play/Pause button is pressed again. Also the time elapsed of the track will freeze. If the CD is left in the paused state for more than 30 minutes, it will stop and return to the start of the disc.

To skip to the next track, press the Next Track button on either the remote or the unit and playback will move on to the next track. The right hand indicator LED will flash.

Returning to the start of the track depends on a couple of scenarios:

- If track time is <5s, single press of prev will select previous track
- If track time is >5s, single press of prev will return to the start of the track, a second press will take it to the previous track. The left hand indicator LED will flash.

To seek through the track press and hold either the Next Track or Previous Track buttons on the remote or unit to scan through the current track. The indicator LED will stay illuminated while seeking through the track (button pressed).

Shuffle and repeat functions are controlled by a single button on the remote. A single press of the Shuffle/ Repeat button will enable repeat track playback, a second press will enable repeat all and a third press will enable shuffle. The following icons will be displayed. It is only possible to change this during playback of the CD.

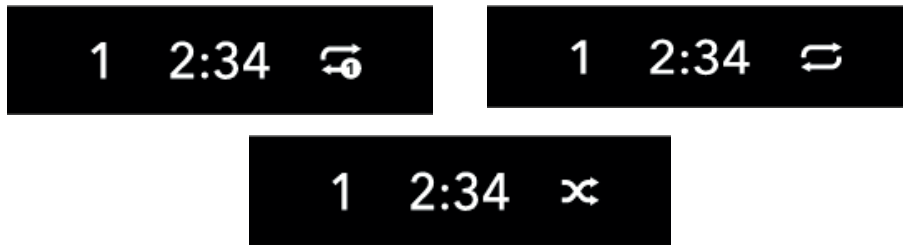

To stop playback, a single press of the Open/ Close & Stop button on the remote or unit will stop playback and the display will show the total number of tracks and time again.

Options Menu

The options button on the remote brings up some customisation options for the CD Transport.

Standby Plus

This feature enables MaestroUnite Systems to turn on from standby and share status while in standby. With the feature turned on, the CD Transport will consume a little more power (see specifications) but is in a ready state to be able to be woken from standby by the Streamer/ Integrated Amplifier that it is in a system with.

When Standby Plus is off, the BLE communication with the MaestroUnite App and the other units in the system will not work.

It is toggled on and off by pressing the Play/ Pause button on the remote.



MAC Addresses

Here you will find the MAC addresses for the bluetooth module.

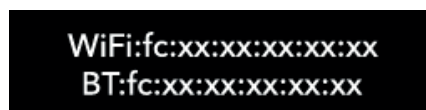

Firmware Versions

Here the firmware versions for the CD Transport and the CD Servo.

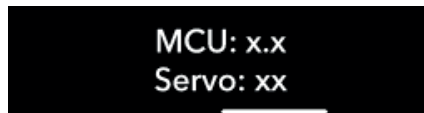

Serial Number

Here the serial number of the product will be displayed.



MaestroUnite App

The Attesa range is accompanied by the MaestroUnite app. This app is used to create systems of CD Transports, Integrated and Streaming Amplifiers. It will also be the home to all user manuals, OTA (Over The Air) updates and connecting the devices to the Wi-Fi network.

The mobile app is available for iOS and Android devices in your usual app store.

Once installed, follow these steps to create your Attesa system and join your product to your WiFi network for over the air updates:



1. Touch on the "+" to start creating a System and name it.

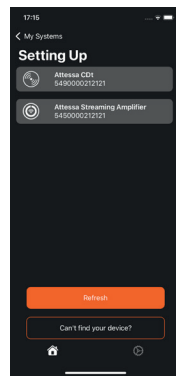

2. Select the first product to add to the system.

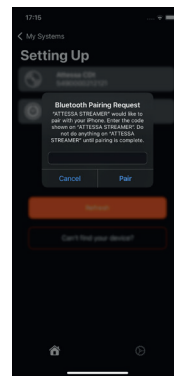

3. Connect via bluetooth by entering the code on the screen of the product

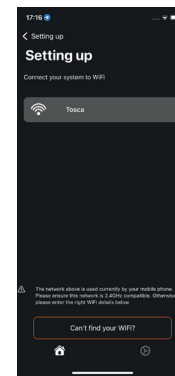

4. Join your local Wi-Fi network

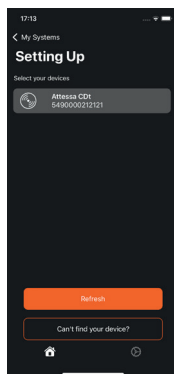

5. Add the next product and connect to it via Bluetooth as done previously

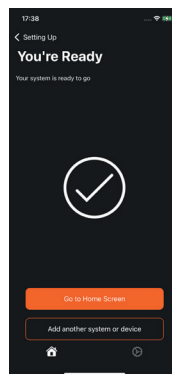

6. Once 2 products have been added, You're Ready. Touch home

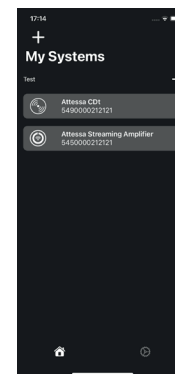

7. Your systems are visible in the home screen where you can select products to customise them

NOTE: When in a "System" the IR receiver is turned off on the CD Transport and the commands are sent by BLE (Bluetooth Low Energy) from the Streaming/ Integrated Amplifier.

NOTE: When in a "System" the CD Transport will turn on automatically when the Streaming/ Integrated Amplifier has the CD input selected. It will also turn off when the Streaming/ Integrated Amplifier is turned off.

The Indicator icons on the CD Transport will not operate when part of a system except when the CD input is selected on the Streaming/ Integrated amplifier when they will become operational. They will flash regardless of whether the track control buttons are pressed on the CD Transport, Streaming/ Integrated AMplifier or the remote.

Factory Reset

Should the need arise to carry out a factory reset on your Atessa Streaming/ Integrated Amplifier, please follow these simple steps.

1. Hold the standby button down for about 20 seconds. During this period, the Power Button LED will turn blue, keep the button pressed. There will be a message appear saying "Hold For Factory Reset" and the LED will turn green. Keep the button pressed in.

Hold For Factory Reset

2. Next a message saying "Factory Reset". Release the button now and the Cd Transport will restart.

Factory Reset

3. To complete the procedure, remove the mains supply from the product once it has gone into standby. Then reconnect it and turn on from stand by.

 **NOTE:** all Wi-Fi details will be erased as well as any other settings and customisation.

Updates

The MaestroUnite app will notify you if there is a new Roksan Firmware update for the units when you use the app.

The CD Transport needs to connect to the internet to receive the updates. This is done as part of the setup of the MaestroUnite app.

 **NOTE:** The CD Transport only has access to the internet during the updating procedure. There is no other way or need for it to connect to the internet.

If you want to manually search for an update on the CD Transport, press and hold the standby button until the LED in it turns blue. If there is an update available, the display will then scroll through the following messages:

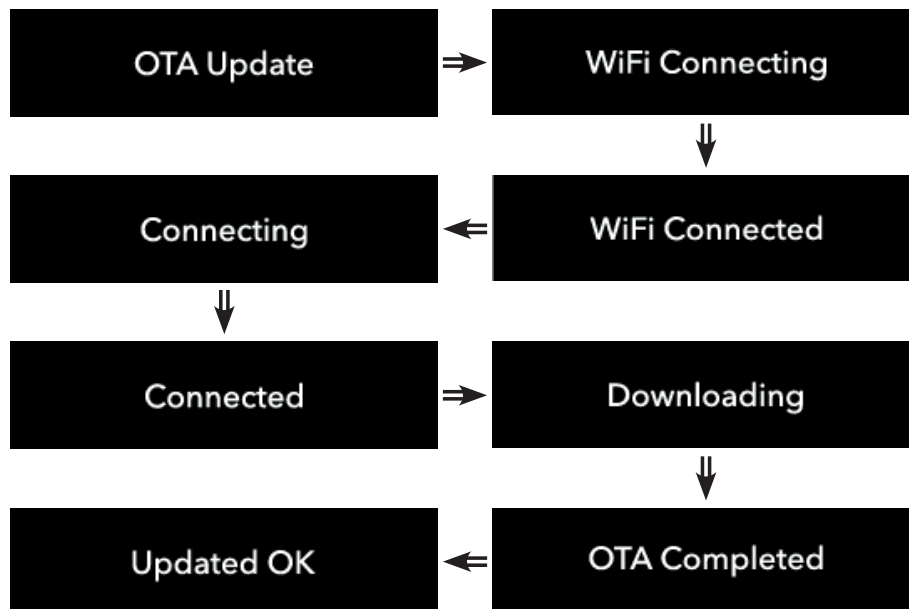

If there isn't an update you will be informed that there isn't one available.

No Updates

Likewise if there is an error, you will also be informed of this.

OTA Failed

Server Fail

Troubleshooting

There may be instances where error messages appear on the screen of the CD Transport. Here are some examples and their descriptions.

Read Error

This error will be displayed if there is an error reading the disc. Try removing the disc, inspect it for scratches and clean with a dry cloth.



OTA Failed

You will get this error if the Over The Air update has failed. This might be followed by an additional message from the below list. If this happens, try restarting the update. If it continues, reboot the CD Transport and also check your network connection.

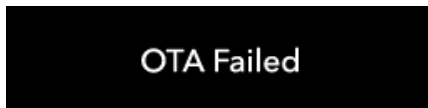

No WiFi Details

This will appear if you try running the update without the CD Transport being registered on the WiFi network. In order to receive OTA updates, you will need to connect it to the WiFi via the Maestro Unite App.



INVALID CERTS

This will only appear if the certificates installed on the CD Transport have become corrupt, are wrong or have expired. Unfortunately, the unit will have to be returned to us to be reprogrammed and cannot be repaired by OTA update or factory reset.



Wrong FW Version

This will be displayed if you are trying to install the wrong firmware either for another product or an older version

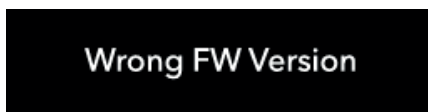

Specifications

CD Support	CD/ CD-R
Gapless	Yes
Digital Output	SPDIF coaxial (16bit/ 44.1 kHz) 1V p-p 75 Ohm characteristic impedance
Construction	Formed plated steel and bespoke machined anodised aluminium front panel
Dimensions (H x W x D) (Inc Feet, Connectors & Buttons)	76 x 432 x 349 mm 3 x 17 x 13 ^{3/4} Inches
Weight	6.1 Kgs 13 lb 6 Oz
Mains input (Auto Selecting)	100-130 VAC 50/60 Hz 210-240 VAC 50/60 Hz
Power consumption	Max: 20 W Standby: <0.5 W Standby Plus Enabled: 0.5 - 1 W

ROKSAN

**MONITOR
AUDIO
GROUP**

**UK
CA**

 Read me, keep me
or recycle me

Monitor Audio Group
24 Brook Road, Rayleigh, Essex
SS6 7XJ
England
Tel: +44 (0)1268 740580
Email: info@roksan.com
roksan.com

©Monitor Audio Ltd. VI-2021

Tested against version 3.0.0 Chassis Firmware

**Designed and engineered
in Great Britain, made in China**