

3 YEAR
WARRANTY

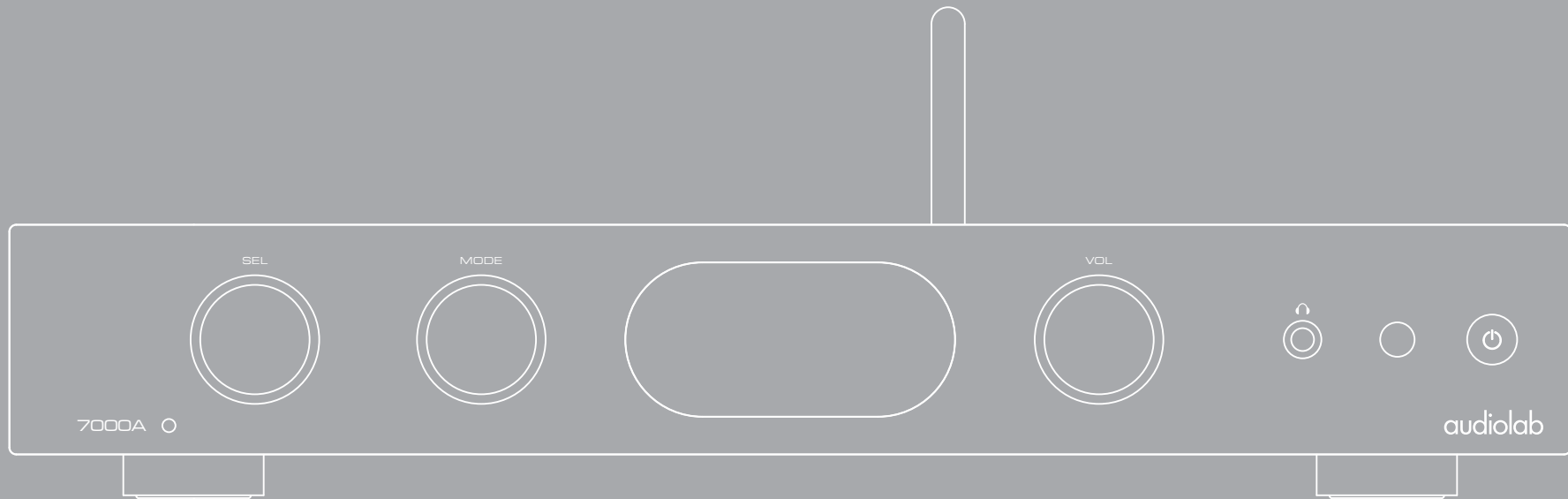

Scan the QR code using a smart-phone device,
for product warranty registration online.



7000A User Manual

audiolab

1: Important Safety Information



This lightning flash with an arrowhead symbol within an equilateral triangle is intended to alert the user to the presence of non-insulated "dangerous voltage" within the product's enclosure that may be of sufficient magnitude to constitute a risk of electric shock.

Warning: To reduce the risk of electric shock, do not remove the cover (or back) as there are no user-serviceable parts inside. Refer servicing to qualified personnel.

The exclamation point within an equilateral triangle is intended to alert the user to the presence of important operating and maintenance instructions in the literature accompanying the appliance.

Read these instructions.

Keep these instructions.

Heed all warnings.

Follow all instructions.

Do not use this apparatus near water.

Clean only with a dry cloth.

Do not block any ventilation openings. Install under the manufacturer's instructions.

Do not install near any heat sources such as radiators, heat registers, stoves, or other apparatus (including amplifiers) that produce heat.

Do not defeat the safety purpose of the polarized or grounding-type plug. A polarized plug has two blades with one wider than the other. A grounding plug has two blades and a third grounding prong. The wide blade or the third prong is provided for your safety. If the provided plug does not fit into your outlet, consult an electrician for the replacement of the obsolete outlet.

Protect the power cord from being stepped on or pinched, particularly at the plugs, convenience receptacles, and at the point where they exit from the apparatus.

Unplug this apparatus during lightning storms or when unused for long periods.

Refer all servicing to qualified service personnel. Servicing is required when the apparatus has been damaged in any way, such as power supply cord or plug is damaged, liquid has been spilt or objects have fallen into the apparatus, the apparatus has been exposed to rain or moisture, does not operate normally, or has been dropped.

CAUTION: These servicing instructions are for use by qualified service personnel only. To reduce the risk of electric shock, do not perform any servicing other than that contained in the operating instructions unless you are qualified to do so.

Do not install this equipment in a confined or built-in space such as a bookcase or similar unit, and keep well ventilated in an open space. The ventilation should not be impeded by covering the ventilation openings with items such as newspaper, tablecloths, curtains etc.

WARNING: Only use attachments/accessories specified or provided by the manufacturer (such as the exclusive supply adapter, battery etc).

WARNING: Please refer to the information on the exterior panel of the enclosure for electrical and safety information before installing or operating the apparatus.

WARNING: To reduce the risk of fire or electric shock, do not expose this apparatus to rain or moisture. The apparatus shall not be exposed to dripping or splashing and objects filled with liquids, such as vases, shall not be placed on the apparatus.

WARNING: For the terminals marked with the symbol "⚡" may be of sufficient magnitude to constitute a risk of electric shock. The external wiring connected to the terminals requires installation by an instructed person or the use of ready-made leads or cords.



Ground protection terminal. This product should be connected to a power outlet with ground protection.

Denmark: Apparatets stikprop skal tilsluttes en stikkontakt med jord, som giver forbindelse til stikproppens jord.

Finland: Laite on liitettävä suojakoskettimilla varustettuun pistorasiaan.

Norway: Apparatet må tilkoples jordet stikkontakt.

Sweden: Apparatens skall anslutas till jordat uttag.

WARNING: No naked flame sources, such as lighted candles, should be placed on the apparatus.

WARNING: Attention should be drawn to the environmental aspects of battery disposal.

WARNING: Use of the apparatus in tropical climates.

THE FUSE VALUES ARE:

220 – 240V (UK, China, etc.) T3.15AL 250V Slow Blow

100 – 120V (USA, Japan, etc.) T6.3AL 250V Slow Blow

1 : Important Safety Information

FCC Statement

This equipment has been tested and found to comply with the limits for a Class B digital device, pursuant to part 15 of the FCC Rules. These limits are designed to provide reasonable protection against harmful interference in a residential installation. This equipment generates, uses and can radiate radio frequency energy and, if not installed and used in accordance with the instructions, may cause harmful interference to radio communications.

However, there is no guarantee that interference will not occur in a particular installation. If this equipment does cause harmful interference to radio or television reception, which can be determined by turning the equipment off and on, the user is encouraged to try to correct the interference by one or more of the following measures:

- Reorient or relocate the receiving antenna.
- Increase the separation between the equipment and receiver.
- Connect the equipment into an outlet on a circuit different from that to which the receiver is connected.
- Consult the dealer or an experienced radio/TV technician for help.

Caution: Any changes or modifications to this device not explicitly approved by the manufacturer could void your authority to operate this equipment. This device complies with part 15 of the FCC Rules. Operation is subject to the following two conditions:

- 1) This device may not cause harmful interference, and
- 2) This device must accept any interference received, including interference that may cause undesired operations.

RF Exposure Information

- The device has been evaluated to meet general RF exposure requirements.
- The device can be used in portable exposure condition and compliance with exposure requirements.

ISED Statement

This device contains license-exempt transmitter (s) / receiver (s) that comply with Innovation, Science and Economic Development Canada's licence-exempt RSS (s). Operation is subject to the following two conditions:

- 1) This device may not cause interference.
- 2) This device must accept any interference, including interference that may cause undesired operation of the device.

The digital apparatus complies with Canadian CAN ICES-3 (B) / NMB-3 (B).

This device meets the exemption from the routine evaluation limits in section 2.5 of RSS 102 and compliance with RSS 102 RF exposure, users can obtain Canadian information on RF exposure and compliance.

This equipment complies with Canada's radiation exposure limits set forth for an uncontrolled environment.

The device has been evaluated to meet general RF exposure requirements.

This equipment should be installed and operated with a minimum distance of 0mm between the radiator & your body.



The Bluetooth® word mark and logos are registered trademarks, owned by Bluetooth SIG, Inc. and any use of such marks by IAG Group Ltd is under license. Other trademarks and trade names are those of their respective owners.



aptX® software is copyright CSR plc. or its group companies. All rights reserved. The aptX® mark and the aptX® logo are trademarks of CSR plc. or one of its group companies and may be registered in one or more jurisdictions.



Being Roon Tested means that IAG Group Ltd and Roon have collaborated to ensure you have the best experience using Roon, software and IAG Group Ltd equipment together, so you can just enjoy the music.



MQA (Master Quality Authenticated) MQA is an award-winning British technology that delivers the sound of the original master recording. The master MQA file is fully authenticated and is small enough to stream or download. Visit mqa.co.uk for more information. 7000A includes MQA technology, which enables you to playback MQA audio files and streams, delivering the sound of the original master recording.

MQA and the Sound Wave Device are registered trademarks of MQA Limited ©2016



The Audiolab 7000A MQA on-screen indicator glows green or blue to indicate that the unit is decoding and playing an MQA stream or file, and denotes provenance to ensure that the sound is identical to that of the source material. It glows blue to indicate it is playing an MQA Studio file, which has either been approved in the studio by the artist/producer or has been verified by the copyright owner. It glows magenta to indicate that the unit is rendering an MQA stream or file. This delivers the final unfold of the MQA file.

2: Contents

Audiolab 7000A

Getting Started	5
Controls and Functions	6
Remote Handset	7
Connections	8
Menu Options	10
System Operations	13
Warranty Coverage	17
Specifications	19

3: Getting Started

Page 5

Introduction of 7000A

The new Audiolab 7000 series follows in the footsteps of the award-winning 8000 and 8200 series but also bridges that between the phenomenally successful 6000 series and the new high-end 9000 series.

Outwardly resembling the sequential series and therefore offering a brand-wide visual aesthetic match, the Audiolab 7000A offers a 70W per channel output, a new DAC, a new full-colour IPS LCD screen and more! It maintains crisp ergonomics, high-quality engineering, a useful range of facilities and an excellent all-around acoustic performance and connectivity.

Features

- Full DAC (ES9038Q2M) and preamp facilities
- High-performance phono pre-amp
- Analogue and digital source connectivity
- Bluetooth aptX, aptX HD receiver
- Powerful stereo amplification
- Dedicated headphone amplifier
- 48 x 64mm full view IPS LCD screen

Inputs

- Three unbalanced analogue input pairs (AUX1, 2, 3)
- One unbalanced MM Phono input pair
- One unbalanced analogue power-amp input pair
- Two Optical and two COAX SPDIF digital inputs
- One 12V Trigger input
- Bluetooth 5.1 (aptX/aptX HD) input
- USB 2.0 port for replaying audio from a compatible host
- One HDMI ARC input

Outputs

- Pre-amplifier output
- Loudspeaker output
- Headphone output
- 12V trigger output

Unpacking the Equipment

The carton should contain:

- The Audiolab 7000A
- One IEC power cord suitable for your area
- One remote handset
- One instruction manual

Please note: The remote control requires 2 x AAA type batteries. Due to international shipping and courier regulations with Lithium-Ion batteries, the remote controller battery is not included in this package.

Consult the dealer from whom you purchased the equipment if any item is not present. Carefully unpack the unit and accessories. Take care not to damage the surface finish when undoing the protective polythene sleeve. Retain the packing materials for future use. Retain the user manual and information concerning the date and place of purchase of your equipment for future reference. If you transfer the unit to a third party, please pass on this instruction manual along with the equipment.

USB Drivers (and Firmware Updates)

To download Windows Drivers, please see the separate manual. Any firmware updates will also be available from www.audiolab.co.uk

Placement

The unit must be mounted on a solid, level and stable surface.

Before you connect the Audiolab 7000A to the AC mains power, ensure your AC mains voltage corresponds to the rating on the rear panel of the product. If in doubt, consult your dealer. If you move to an area that has a different mains voltage, seek advice from an Audiolab appointed dealer or a competent service technician.

4: Controls and Functions

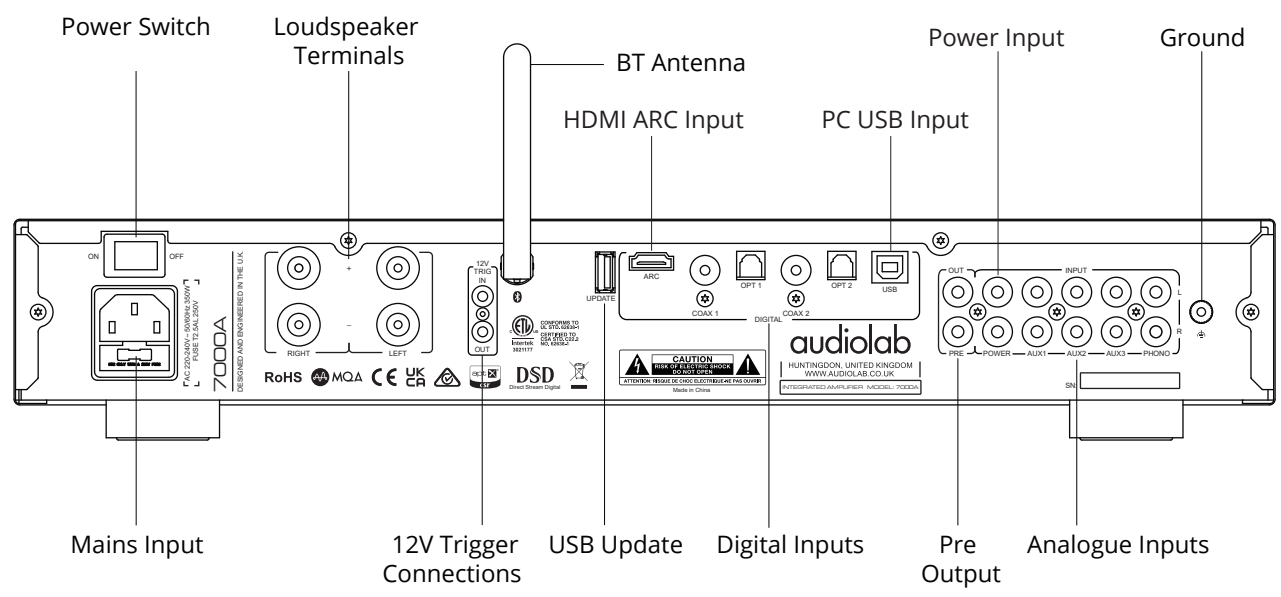
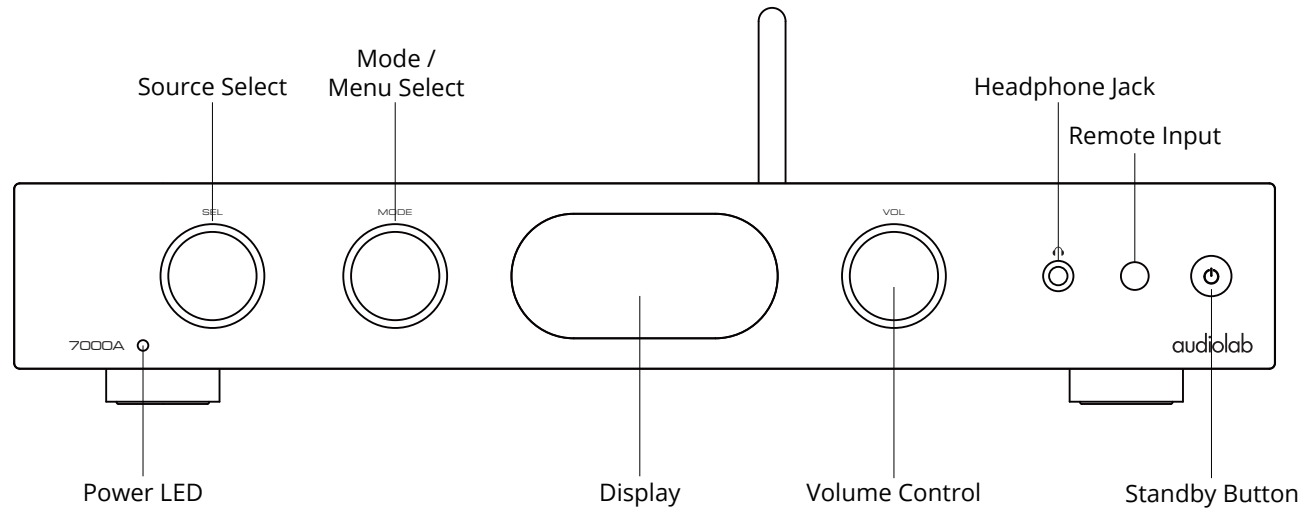

5: Remote Handset

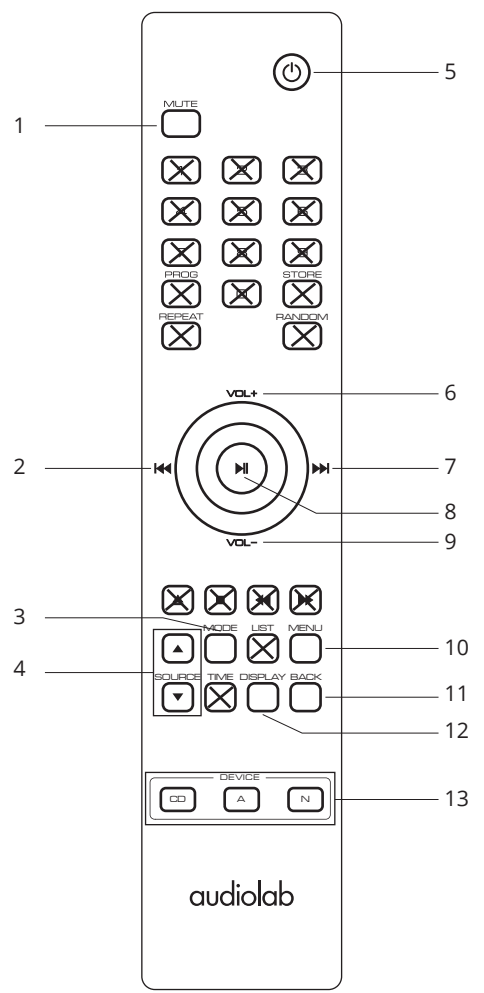

- 1. MUTE Press to mute or unmute the 7000A
- 2. ◀◀ Navigate back through Menu options, reduce brightness, power-on volume, input sensitivity or scroll up menu list options
- 3. MODE Press to select Pre / Integrated / Pre-Power mode
- 4. SOURCE Press to select the input source
- 5. STANDBY Press to put the unit in, or bring it out of standby
- 6. VOL+ Increase Volume / Menu settings previous option
- 7. ▶▶ Navigate forward through Menu options, increase brightness, power-on volume, input sensitivity or scroll down menu list options
- 8. ▶|| Confirm and apply changes in Menu options, or enter a menu sub-directory
- 9. VOL- Decrease Volume / Menu settings next option
- 10. MENU Press to access the setup Menu
- 11. BACK Press to go back up one level in the Menu, or exit to the home screen
- 12. DISPLAY Press to toggle the display options
- 13. CD/A/N Press to select the device - CD / A / N

Fit the Batteries

Open the cover and insert 2 x AAA batteries (not supplied), replace the cover.

Always use AAA batteries and replace them in sets – never mix up old and new batteries. Very weak batteries can leak and damage the handset. Replace them in good time!

Note: there is a risk of fire and injury if a battery is handled improperly. Do not disassemble, crush, puncture, short the contacts or dispose of the batteries in fire or water. Do not attempt to open or service a battery. Discard used batteries in full accordance with recycling regulations in force in your area.

Handset Operation

Point the handset at the remote receiver and press the buttons as illustrated to activate the relevant functions.

The handset should be within 15 metres of the player and there should be a clear line of sight between the handset and the unit for optimum remote control operation.

Note: The buttons shown crossed out are for use with other Audiolab units and offer no function on the 7000A.

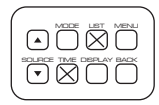

For example, the 'LIST' and 'TIME' buttons do not offer any function with the 7000A.

6: Connections

Mains Input

Before connecting the AC power cord to the 7000A, please make sure the Power Switch is in the OFF position. Switch it to the ON position after connecting the unit to the AC mains.

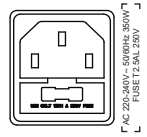

Loudspeaker Terminals

Connect your loudspeaker signal cable.

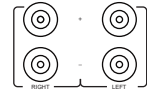

12V Trigger Connections

The 7000A features two 12V Trigger connections, one output and one input. Use the output to control other products (ie. Audiolab 7000CDT, 7000N PLAY or third party compatible equipment). Use the input when the 7000A is to be controlled by other equipment.

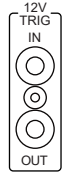

The 12V Trigger connections are made using 3.5mm to 3.5mm jack interconnects (not included).

PC USB Input

Connect your computer to the 7000A via a USB cable (Type-A to Type-B). Select the PC USB source using the handset or the SELECT button on the front panel.

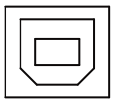

'No Input Signal' will be displayed if there is no input signal to the USB input. When you play a file the digital inputs will lock onto the digital signal as soon as there is an input signal for USB. The display screen will then show the output sampling frequency of the music file being played from your computer.

To download Windows Drivers, please see the separate manual included with this device or visit audiolab.co.uk/downloads. The manual and Drivers will also be available from www.audiolab.co.uk

Bluetooth Connection



Select the BT source option on the 7000A. On your Bluetooth transmitter device (ie. smartphone, tablet or PC) use the BT device menu to locate 'audiolab 7000A-xxxx' and connect. Once paired, the Bluetooth icon will appear on the 7000A display. If you switch to another input on the 7000A your mobile device will be disconnected after 60 seconds.

To reconnect, select BT on the 7000A and it will automatically connect to the last paired device (if the device is within range). Or select 'audiolab 7000A-xxxx' on your device in the Bluetooth menu and it will reconnect. Once paired, you can disconnect your mobile device with 7000A by long pressing the **▶||** button on the remote controller.

USB Update

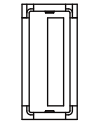

UPDATE

Any official Audiolab update will be provided by download from audiolab.co.uk

Please read and follow any instructions provided with any such download.

POWER OFF the 7000A unit. Insert the USB storage device, onto which the USB update files have been loaded. Press the STANDBY button on the front panel then simultaneously POWER ON, your 7000A will upgrade automatically.

Wait for the device display to confirm that the update is completed. Then, unplug the USB drive and restart the 7000A. The unit is now ready to use.

Note: The USB Update port can also be used to sync volume control between the 7000A and 7000N Play. Simply connect a Type A to Type B USB cable between the 7000A USB Update port and the 7000N Play Control port. Please refer to Menu Options on page 11 of this manual for more information.

6: Connections Page 9

Optical Digital Input

Connect your optical digital sources to either OPT1 or OPT2.

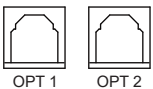

Coaxial Digital Input

Connect your coaxial digital sources to either COAX1 or COAX2.

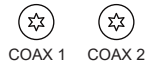

ARC Digital Input

ARC function allows you to send audio from your ARC-compliant TV to 7000A through a single HDMI connection. To enjoy the ARC function, please ensure your TV is both HDMI-CEC and ARC compliant and set up accordingly.



Please note:
Your TV must support the HDMI-CEC and ARC functions.

HDMI-CEC and ARC must be set to on. The configuration method of HDMI-CEC and ARC differ depending on the brand or model of your TV. For details about the ARC function, please refer to your TV owner's manual.

Only HDMI 1.4 cables can support the ARC function.

Pre-Amplifier Output

Pre-amplifier output for driving external power amplifiers, subwoofers or signal processors.

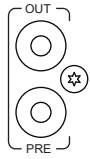

Analogue Inputs (Line)

Connect your analogue sources to one of the three line-level inputs, AUX1, AUX2 or AUX3.

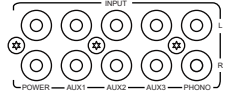

Power Input

Power input for driving the power amplifier input directly from an external source. Only operates when Pre-ower Mode is selected.

Phono Input (MM)

Connect your turntable (with a moving magnet cartridge) to the phono input. Connect the earth lead from your turntable (if available) to the ground terminal.

Headphone Output

A stereo 6.3mm (1/4") jack is provided on the front panel for connecting headphones. When headphones are connected the audio to the loudspeaker terminals will be deactivated.



7: Menu Options

Filter

Configure the digital filter for the audio DAC. Linear Phase (Slow Roll-Off) is the default setting.

- Linear (Fast): This is the most common filter with clean overall suppression and excellent rejection, best for music with large transients. Provides crisp clean highs.
- Linear (Slow): A low group delay and symmetrical input response with less ringing than 'Linear-phase fast roll-off'. It offers punchier bass than 'Linear-phase fast roll-off', with clean highs. (Default)
- Minimum (Fast): This offers minimal pre-ringing. It is usually preferred for imaging and sound stages. It offers no aliasing in the frequency domain and stronger bass than 'Linear Phase', with clean highs.
- Minimum (Slow): A Non-Symmetrical filter designed to minimise pre-ringing. It offers a strong punchy bass with a good transient attack.
- Hybrid: This is the combination of 'Linear-phase' and 'Minimum-phase'. It offers a fast transient attack, strong punchy bass and crisp highs.

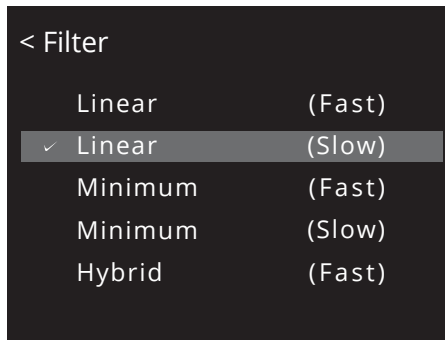

DPLL

This setting is used for changing the bandwidth of the digital phase lock loop of the D/A converter to accommodate different levels of jitter on the incoming SPDIF signal.

Normal mode should be selected for signals with low jitter, while Wide mode should be selected for signals with abnormal jitter.

For best audio quality leave this setting at the default value Normal, only use Wide for a given input if the system is having problems locking onto the source.

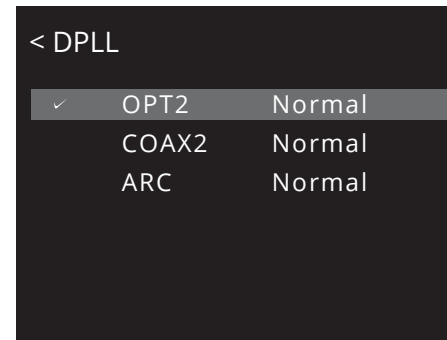

Balance

Adjust the Left and Right balance of the 7000A audio output.

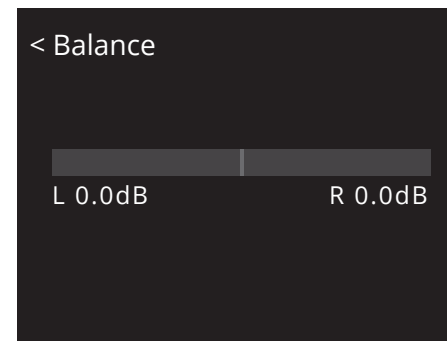

Upsampling

The 7000A will automatically upsample the incoming digital audio signal (SPDIF or PC USB) to 352.8KHz or 384KHz.

The upsampling can be turned OFF if required.

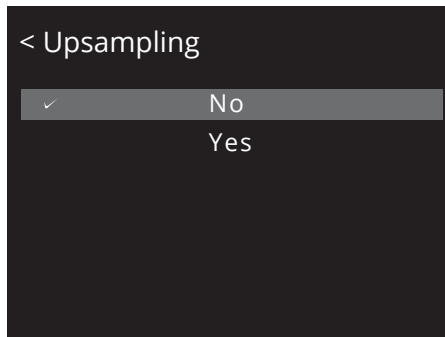

Input Sensitivity

This feature allows the input sensitivity of the individual analogue inputs to be adjusted (+/- 6dB) to help achieve a more uniform playback volume level when switching from one source to another.

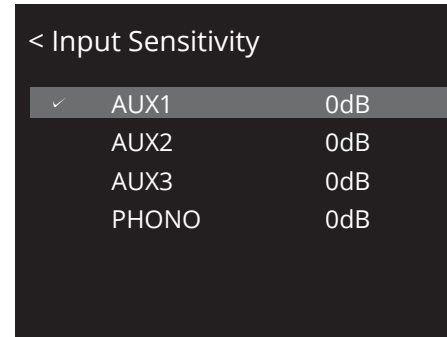

7: Menu Options

Volume

• Power On Limit

Power On Limit sets the maximum volume level as the unit is switched on.

When coming out of standby, the volume setting will be set to the level that was used at the end of the previous operating session OR to the Power On Limit value set in this menu, whichever is lowest.

This will avoid a sudden loud signal at the beginning of a new session.

• Sync

The 7000A volume adjustment can sync with the Audiolab 7000N Play when a Type A to Type B USB cable is connected between the 7000A Update port and the 7000N Play Control port. This enables the DTS Play-Fi app to conveniently control the 7000A volume.

Volume Sync is set to 'On' by default. If the 7000A is being used as a standalone integrated amplifier, or when you are not using the 7000N Play, you can set Volume Sync to 'Off'.

Display Option

Access the various display options for the 7000A front panel display.

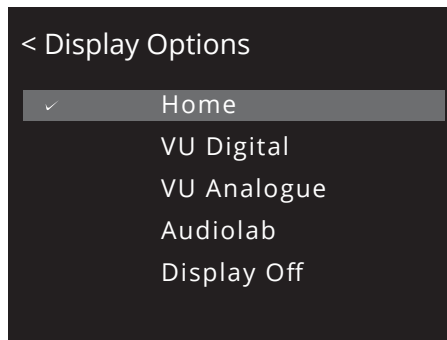
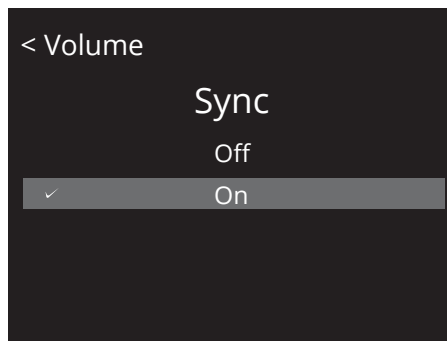
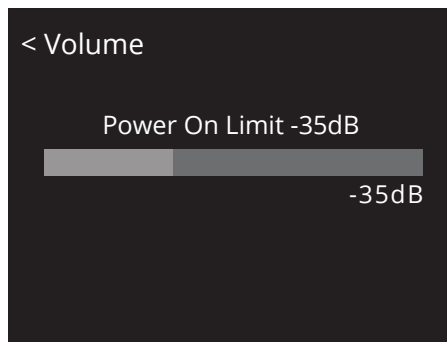

Brightness

Adjust the brightness of the 7000A front panel display.

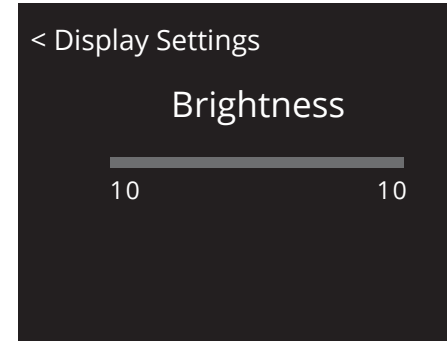

Display Time Out

Adjust the time at which the 7000A display will revert to your chosen display option, from the home screen, after performing volume adjustment and other operations.

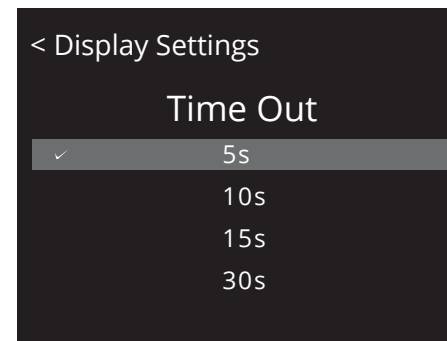

Animation

Activate (ON) or deactivate (OFF) the animations shown on the playback interface display.

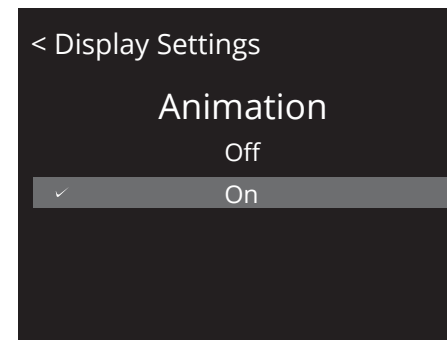

7: Menu Options

CEC

Activate or deactivate the CEC function of the 7000A.

If you want 7000A to sync power on and off with your TV, CEC should be set to 'On'. CEC is set to 'Off' by default, which means it will not auto-power on with your TV set, but still allows 7000A volume control via your TV remote.

Note: CEC performance will vary according to your TV or 3rd party HDMI CEC specification. The CEC code release time varies from device to device, therefore CEC 'On' could cause delays in audio response from the 7000A when powered on by use of the TV remote controller. Other functions are not affected.

Trigger

Activate or deactivate the 12V trigger function of the 7000A.

Language

The 7000A offers multiple language options for the GUI. Select your chosen language from the list. The default language is 'English'.

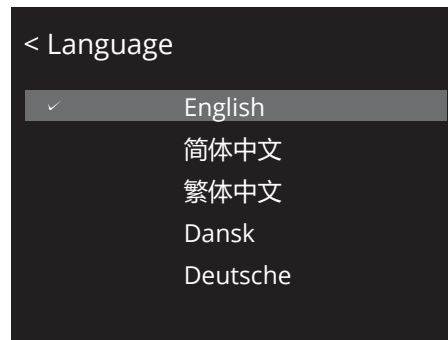
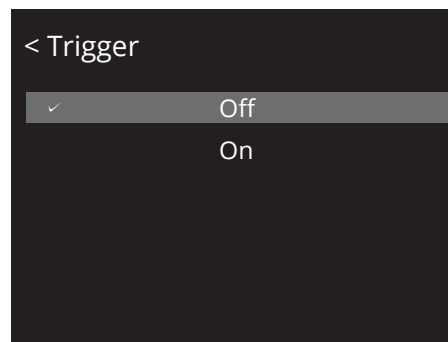
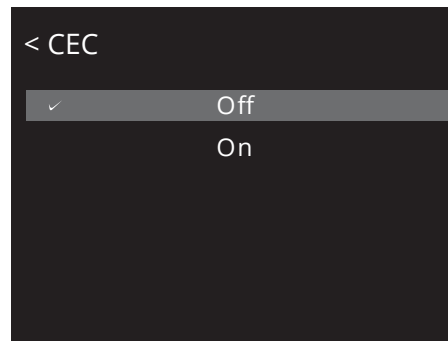

Standby

The auto-standby feature will put the 7000A into a standby model after 20 minutes of inactivity. This feature can be also user-defined and set to 20 minutes, 60 minutes or 'never'. The latter option means that the 7000A will not enter standby mode without user instruction by way of the front panel 'standby' button or remote control 'standby' button.

Reset

Reset the 7000A to the factory default settings.

Version

Check the current operational firmware version.

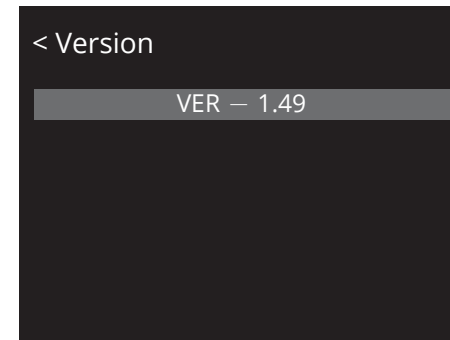
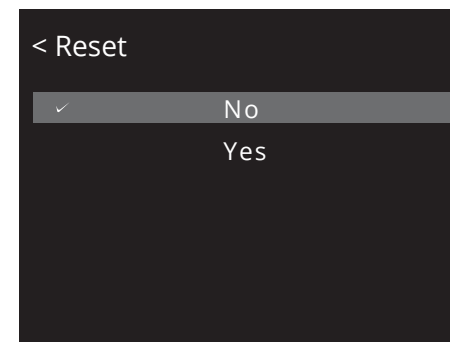
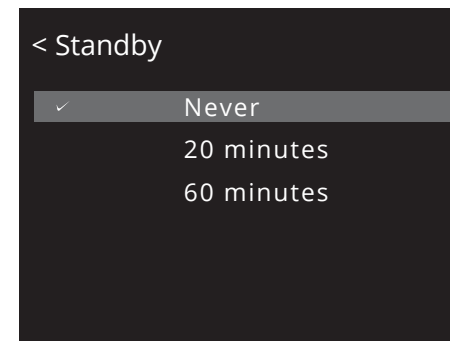

8: System Operations

Switching On and Off

When powering on your system, make sure to power on additional components (such as 7000CDT or a turntable etc.) before powering on the 7000A.

When powering your system off, first turn off the 7000A followed by additional components.

Standby Mode

After initial powering on, the 7000A will be in 'Standby' mode. To use the 7000A, press the 'Standby' button to bring the 7000A out of standby mode. The power indicator LED will become brighter and the display will show the 'Audiolab' welcome screen as the unit enters operational mode.

If the system is connected via the 12V Triggers, putting the 7000A (master device) on standby will put all slave devices in standby mode simultaneously.

Also, if using the remote control, pressing STANDBY will put the 7000A, 7000CDT and 7000N Play into standby simultaneously. No 12V Triggers are needed.

Source Select

Rotate the SELECT knob on the front panel or use the source (▼ or ▲) buttons on the remote handset to select different input sources.

In addition, you can hold the source (▼ or ▲) buttons on the remote handset to enter the visual input selection option on the GUI display. Cycle through the options by rotating the SELECT knob or the navigation buttons on the remote controller. By press the SELECT knob or the button on the remote handset to confirm.

Volume Control

Rotate the VOL knob on the front panel, or use the Volume up/ down keys on the remote control, to set the volume level. The range is -78dB to 0dB, the factory default volume setting is -30dB. When coming out of standby the 7000A will be set to the previously used volume setting, except if louder than -20dB, in which case the volume will default to -20dB. You can change the limit, please see the Menu options for the Power On Limit feature.

Mute

Press the VOL knob on the front panel or the MUTE button on the remote handset to mute / unmute the 7000A.

Alternative Display Options

The Audiolab 7000A has an intelligent and versatile display. You can access the display options via the menu function.

Press the MENU on the remote control to enter menu mode, or press the MODE Knob on the front panel of the device.

Navigate to 'Display Options' via the menu options (use the Vol +/- buttons on the remote or MODE knob on the front panel of the device for navigation). Choose and confirm by ► on the remote control or MODE knob on the front panel of the device.

Or you can just press the DISPLAY on the remote control to cycle the display options. Here, you will have access to the following display options:

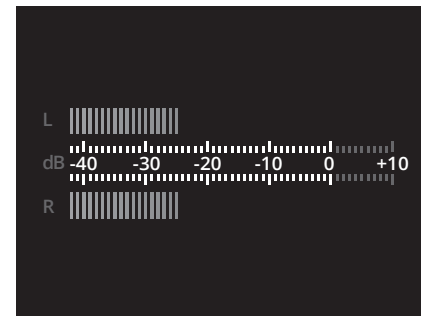

Digital VU

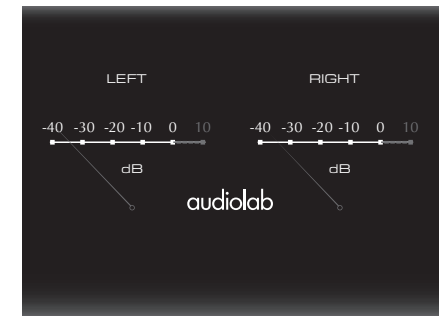

Analogue VU

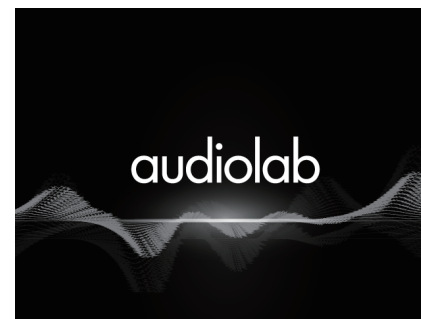

Audiolab

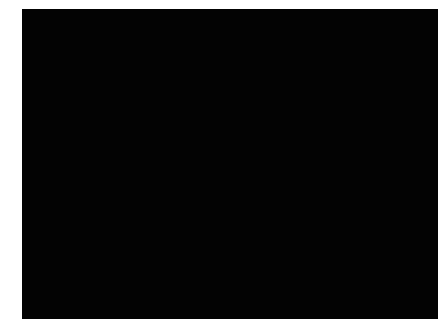

Display Off

8: System Operations

Operating Mode

Although the 7000A is an integrated amplifier it can function as a separate pre and power amplifier. Rotate the MODE knob on the front panel or press the MODE key on the remote control to select different operating modes.

MODE	POWER AMP IN	PRE OUT	HEADPHONE OUT	LOUDSPEAKERS
Pre	DISABLED	ACTIVE	ACTIVE	DISABLED
Pre POWER	ACTIVE	ACTIVE	ACTIVE	ACTIVE
INTEGRATED	DISABLED	ACTIVE	ACTIVE	ACTIVE

Integrated Mode

The pre-amplifier section is internally connected to the power amplifier, pre-amplifier output is also operational in this mode. A second power amplifier can be connected for bi-amplification as shown in the diagram.

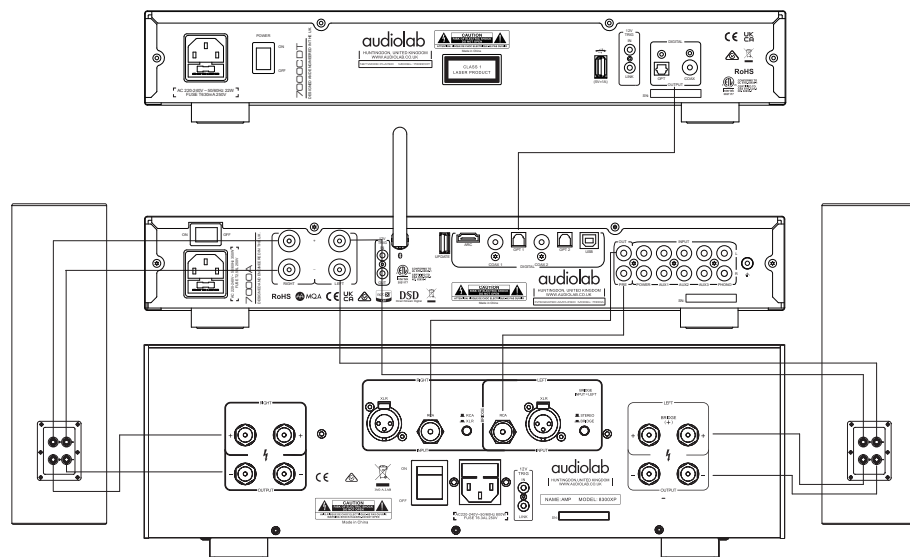

Pre-power Mode

The preamplifier section is internally disconnected from the power amplifier. The 7000A can be used as a stand-alone power amplifier (ie. part of an AV setup). This mode can also be used if additional signal processing is required, connecting the pre-out to an external signal processor and then taking the output from the processor to the 7000A Power-IN.

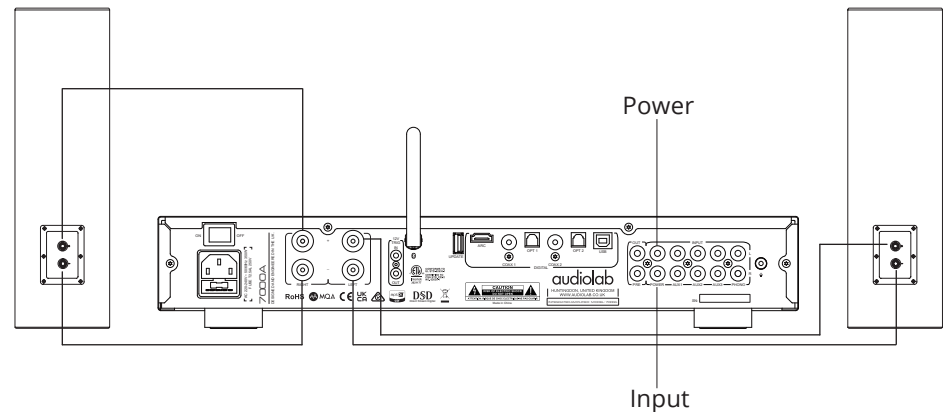

Pre-Mode

All signals to and from the power amplifier of the 7000A are disconnected. In this mode, the 7000A functions as a stand-alone preamplifier. The pre-amplifier section of the 7000A can be connected to a stereo power amplifier or two mono-block amplifiers.

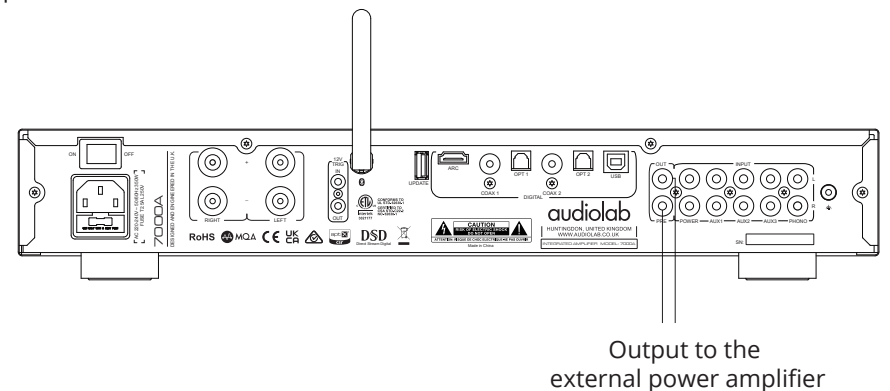

8: System Operations

The Menu

The menu enables you to customize the unit and optimise the interface with other equipment in your system.

Press the 'MENU' key on the remote controller to enter menu mode, and then press 'VOL-' or 'VOL+' to cycle through the menu options.

Press **▶** to access the sub menus and press **▶** again to confirm any selection.

You can also press the MODE knob on the front panel to enter the menu, then rotate it cycle menu options. Press 'MODE' again to enter the sub menu. And, press 'MODE' again to confirm any selection. Long press 'MODE' to go back.

The Menu Tree

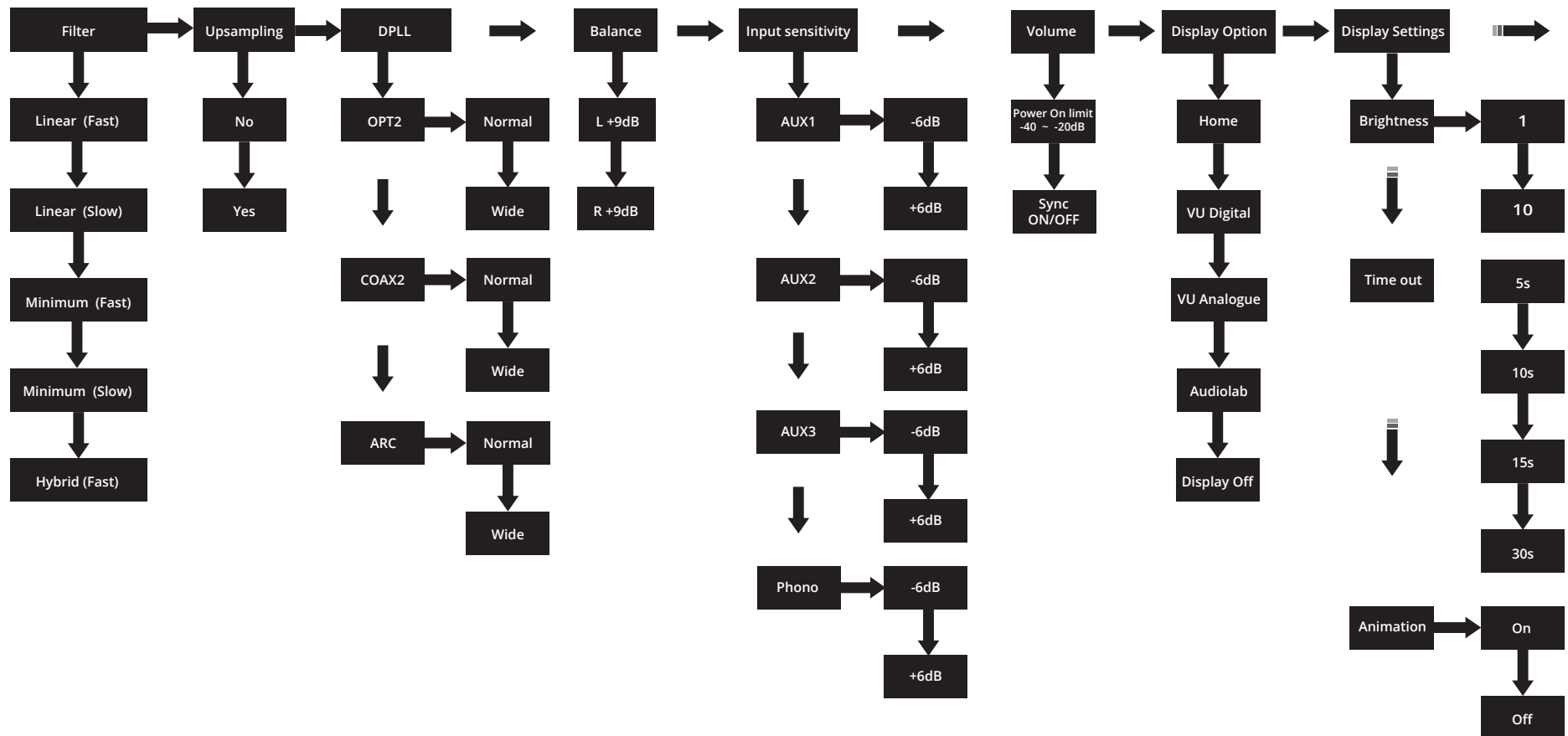

8: System Operations

The Menu Tree

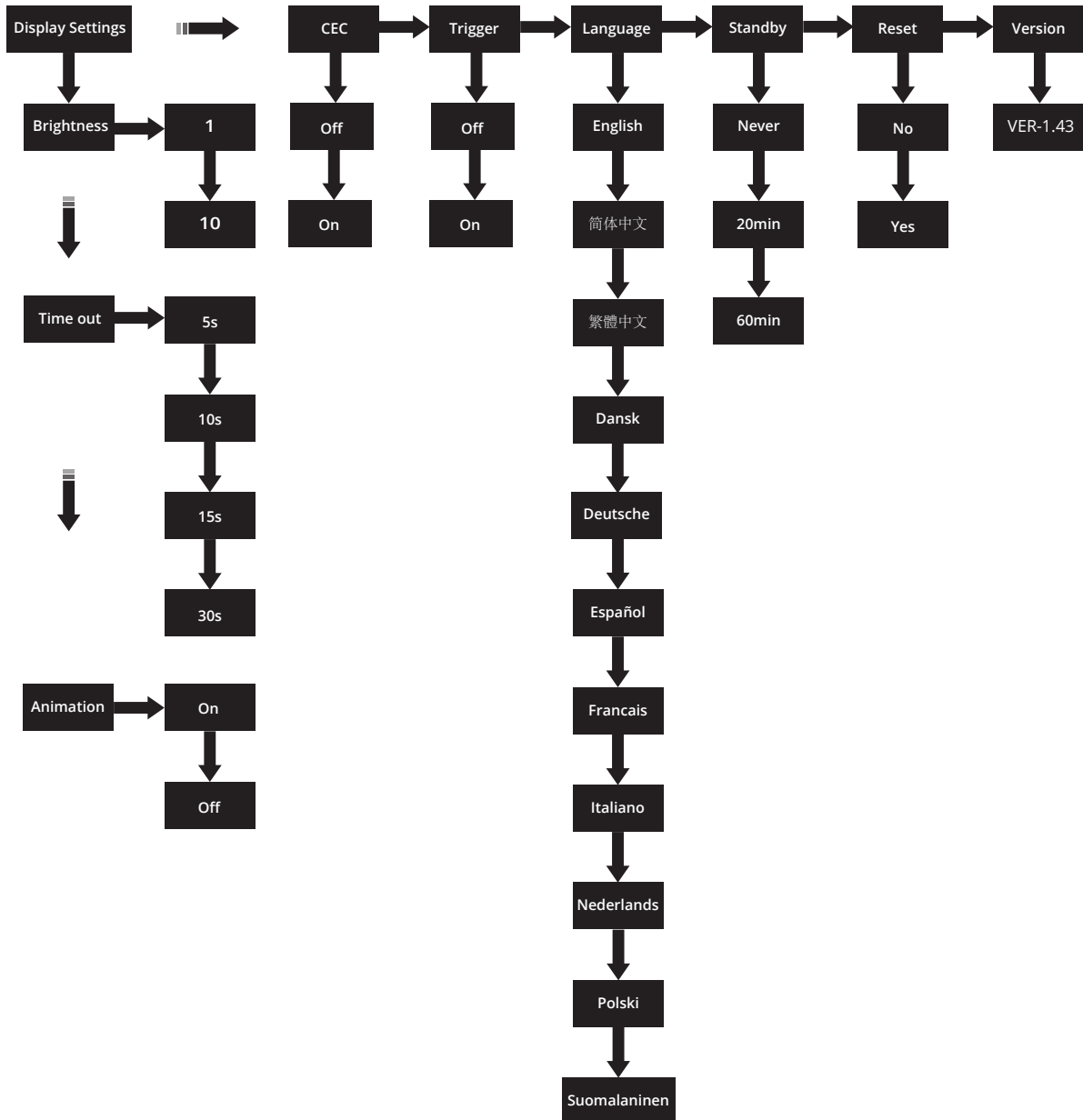

9: Warranty Coverage

Page 17

Audiolab warrants its products, subject to the following terms and conditions below, to be free from defects in materials and workmanship.

Online Registration



Scan the QR code using a smart-phone device, for product warranty registration online.

The three (3) year extended warranty is applicable to items purchased from Jan 1st 2021, onwards. Items purchased prior to this date are not eligible for this extended warranty service but are subject to statutory warranty claims and all applicable consumer rights.

To qualify for the extended 3 year warranty, you must register your product within ninety (90) calendar days from the date of purchase. Visit audiolab.co.uk/warranty-registration to complete your online registration. Items not registered online will have a Limited Warranty for one (1) year, or for the period of your country's statutory warranty, whichever is longer.

Warranty can only be offered to products registered with proof of purchase with date, model and details of the authorised dealer clearly stated on the receipt/invoice. Please keep the original receipt/invoice in case it is required for a warranty claim.

This Limited Warranty is non-transferable and is offered exclusively to the original owner.

This Limited Warranty is valid only in the original country of purchase.

Repairs or replacements are provided under this warranty are the exclusive remedy of the consumer. Audiolab shall not be liable for any incidental or consequential damages for breach of any expenses or implied warranty with any product. Except to the extent prohibited by law, this warranty is exclusive and in lieu of all other warranties whatsoever, both expressed and implied, including but not limited to the warrant of merchantability and fitness for practical purpose.

This warranty provides benefits that are additional to and do not affect your statutory consumer rights.

This Limited Warranty offer is subject to correct information being submitted in your application. Incorrect dates or mismatched purchase receipt dates that are outside of the warranty terms will immediately invalidate any warranty claim.

*Please check with your dealer local distributor for further information.

Exclusions

The following items are excluded from the Audiolab warranty:

Normal wear and tear and cosmetic damage (including but not limited to any wear from reasonable use, environmental deterioration or neglect)

Products on which the serial number has been removed, altered or otherwise made illegible.

Products not purchased from an authorised Audiolab dealer.

Products that were not new at the time of original purchase.

Products sold 'as is', 'as seen' or 'with faults'

Product not purchased from an Authorised Dealer/Distributor within the region of the claim (ie parallel imports or grey market products)

Accidental damage or faults caused by commercial use, acts of God, incorrect installation, incorrect connection, incorrect packaging, misuse or careless operation or handling which is not in accordance with the user instructions.

Equipment that has been operated in conjunction with unsuitable, inappropriate or faulty apparatus.

Repairs, alterations or modifications carried out by parties other than Audiolab or its authorised service partners.

Damage in transit that cannot be attributable to the fault of Audiolab, the authorised distributor or dealer (ie. claims otherwise covered by transit insurance.)

Faults relating to abnormal or inappropriate power supply voltage or power surges.

Faults relating to extremities in temperature, exposure to heat, water or other liquids, insects, excessive moisture, sand, chemicals, battery leakage or any other contaminants.

Any force majeure events, including but not limited to any acts of God, fire, lightning, typhoon, storm, earthquake, hurricane, natural disaster, tsunami, flood, war, riot, public disturbance.

Any other causes beyond the reasonable control of either Audiolab and its Authorised Distributor.

Please note items purchased before 1st Jan 2021 are not eligible for the extended warranty claim.

9: Warranty Coverage

Page 18

How to claim

To obtain warranty service please contact the authorised dealer from which you purchased this product and present the limited warranty certificate offered upon registration of your product's extended warranty offer.

Do not dispatch goods without the prior agreement of the dealer distributor or authorised service centre.

If asked to return products for inspection and or repair, please pack carefully preferably in the original carton or packaging affording an equal degree of protection and returned via insured, trackable courier service.

The authorised dealer or distributor will offer full return details and instructions. However, please note if unsuitable packaging is used the warranty may be deemed void due to improper action in return.

Audiolab or the authorised distributor, dealer or service centre may make a charge for the supply of new packaging for the return of the repaired item. Please note, insurance is recommended as goods are returned at the owner's risk. Authorised distributors or service centres cannot be held liable for loss or damage in transit. Insurance and freight charges on the return journey will be paid for by Audiolab, authorised dealer, distributor or service centre if corrective work proves to be necessary.

In the event of 'no-fault found' or 'no repair necessary', the return shipping charge will be the responsibility of the owner.

Repairs

All repairs will be carried out by the appointed distributor (or locally appointed service centre). Repairs handled or processed without authorisation or approval of the appointed representative will be excluded from this limited warranty. Please note, Audiolab is not able to supply parts or replacement items to any other entity than the official distributor or authorised service centre.

Other than the warranty and services set out in this warranty, to the fullest extent permitted by law, Audiolab shall not be liable to you and/or any third party or entity whatsoever for:

- Any loss, damages and/or malfunction caused to any product(s) which is/are connected to any of the products covered by this warranty.
- Any damages, loss and liability, whether direct, indirect, incidental, consequential special, punitive or otherwise, howsoever caused by, arising out of or otherwise, in relation to the installation, delivery, use, service, repair, replacement and/or maintenance of the product;
- Any damages, loss and liability under this warranty in respect of any act, omission, or negligence of any of their technicians, employees, agents, representatives or independent contractors relating to the actual or purported performance of any of the obligations under this warranty.

Service Centre Address

Should a fault occur with your product, please pack it correctly using the original packing, so you can ship it safely. For technical support, servicing or product queries and information, please contact either your local retailer or the office below:

IAG Service Dept.
13/14 Glebe Road
Huntingdon
Cambridgeshire
PE29 7DL
UK

Tel: +44(0)1480 452561
Email: service@audiolab.co.uk

For information on other authorised service centres worldwide contact Audiolab International, UK.

A worldwide distributors list is available on the Audiolab website: www.audiolab.co.uk

10. Specifications

Model	7000A
General Description	Integrated Amplifier
Design Philosophy and Core Technology	<ul style="list-style-type: none"> - 2 x 70W (8 ohms) / 2 x 110W (4 ohms) Class AB - ES9038Q2M 32-bit DAC - 2.8" (48 x 64mm) Full View IPS LCD - Built in Certified Hardware MQA Full Decoder (PC USB, Coax / Optical) - Bluetooth 5.0 (aptX / aptX LL) Support - Low Noise Moving Magnet Phono Stage - Dedicated Current-Feedback Headphone amp - Integrated / PRE-POWER / PRE only Modes - VU Digital / VU Analogue Meter - USB Upgrade Support
Inputs	3 x Analogue, 1 x Phono (MM), 1 x Power Amplifier, 2 x SPDIF (Coax), 2 x SPDIF (Optical), 1 x HDMI ARC, 1 x PC USB (USB B), 1 x Bluetooth (aptX/aptX LL), 1 x 12V Trigger
Outputs	1 x PRE Amplifier, 1 x Stereo Speaker, 1 x Headphone, 1 x 12V Trigger
Sampling Frequency	Optical / Coaxial: 44.1kHz - 192kHz; PC USB: 44.1kHz-768kHz (PCM) / DSD64, DSD128, DSD256, DSD512
Preamplifier Section	
Gain	+6dB (Line); +55dB (Phono MM)
Input Sensitivity	820mV (Line, Volume = 0dB); 4.4mV (Phone MM, Volume = 0dB)
Input Impedance	10K (Line); 47K // 100pF (Phono MM)
Total Harmonic Distortion (THD)	< 0.0005% (1kHz @ 2V, Volume = 0dB)
Frequency Response	20Hz-20kHz (+/-0.1dB)
Output Voltage	2.3V max. (Volume = 0dB)
Output Impedance	100 ohms
Signal-to-Noise Ratio	> 110dB (Line, A-weighted); > 76dB (Phono MM, A-weighted)
DAC	
D to A Converter	ES9038Q2M
Total Harmonic Distortion (THD)	< 0.0005% (1KHz @ 0dBFS)
Output Level (0dBFS, 1kHz)	2.1Vrms

10. Specifications

Max. Sampling Frequency	Optical, Coaxial: 192kHz; PC USB: PCM768kHz, DSD512
Signal-to-Noise Ratio (S/N)	> 114dB (A-weighted)
Power Amplifier Section	
Gain	+29dB
Rated Power Output	2 x 70W (8 ohms, THD<1%); 2 x 110W (4 ohms, THD<1%)
Frequency Response	20Hz-20kHz (+/-0.3dB)
Total Harmonic Distortion (THD)	<0.003% (1kHz @ 40W / 8 ohms)
Input Sensitivity	720mV
Signal-to-Noise Ratio (S/N)	> 110dB (A-weighted)
Max. Output Current	9A
Headphone Amplifier	
Total Harmonic Distortion (THD)	< 0.01% (1kHz, 50mW)
Output Impedance	4.7 ohms
Load Impedance	20-600 ohms
General	
Standby Power Consumption	<0.5W
Net Weight	8.4kg
Gross Weight	10.7kg
Dimensions (mm) (W x D x H)	444 x 340 x 78
Carton Size (mm) (W x D x H)	500 x 455 x 140
Finish	Black / Silver
Power Requirements (depending on region)	220-240V ~ 50/ 60Hz; 100-120V ~ 50/ 60Hz
Standard Accessories	Power Cord, Remote Control, User Manual, Antennas, etc.



Correct disposal of this product. This marking indicates that this product should not be disposed with other household wastes throughout the EU. To prevent possible harm to the environment or human health from uncontrolled waste disposal, recycle it responsibly to promote the sustainable reuse of material resources. To return your used device, please use the return and collection systems or contact the retailer where the product was purchased. They can take this product for environmental safe recycling.



