

Ci160RR-THX



Architectural Speaker

OBSESSED WITH HIGH RESOLUTION

Product Overview

The KEF Ci160RR-THX is an ultra-high-performance coincident point source loudspeaker designed for in-ceiling or in-wall discreet installations. It features patented Uni-Q® technology with a 25mm high frequency tweeter mounted in the acoustic centre of the 165mm low frequency woofer delivering exceptionally wide dispersion and hi fidelity audio across a large listening area. As a THX® Certified Ultra architectural loudspeaker, Ci160RR-THX is specifically engineered to maintain exceptional sound quality at high outputs. Its performance and design characteristics make the Ci160RR-THX the ideal choice for foreground, background, speech, and cinematic applications including 3D immersive audio formats such as Dolby® Atmos™.



Key Features

KEF “Sit Anywhere” Uni-Q® Technology – This proprietary driver array places the tweeter in the acoustic centre of the woofer delivering wide dispersion with consistent sound characteristics throughout the room. Because the high and low frequencies originate from the same point in space, acoustic lobing problems common to other speaker designs are virtually eliminated and imaging is greatly improved to effectively shift the sound to appear as if it’s originating from behind the video screen.

Tangerine Waveguide™ – In addition to protecting the driver, the Tangerine Waveguide further enhances dispersion allowing for 130 degrees of coverage.

25mm High Frequency Tweeter – The high-power handling aluminium dome tweeter has a wide frequency response and can continuously deliver extremely high output with no audible distortion.

Weather Resistant – Manufactured using a proprietary plating and powder coating process, the KEF Ci160RR-THX is UV protected and designed to withstand harsh operating environments.

IP64 Certification – The speaker passed official IEC testing to ensure that splashing water would have no harmful effects on assembly components.

Ultra-Thin Bezel (UTB) – To maintain a premium aesthetic appearance, the ABS bezel was carefully engineered to be as thin as possible while maintaining the necessary structural rigidity.

Magnetic Grille – For security and ease of installation the grille attaches by a powerful magnetic circuit and can be painted to match any décor.

THX® Certified Ultra* – The KEF Ci160RR-THX endured nearly 500 THX laboratory tests to ensure it delivers full impact entertainment experiences just as the artist intended.

Universal cut-out – All KEF 160mm in-ceiling round speakers utilise the same diameter opening for ease of installation and flexible component selection.

Gold-Plated Spring Loaded Binding Posts – This design improves ease of installation and guarantees consistent wire clamping pressure to ensure proper electrical transfer.

Covered Crossover Circuit – The cover adds structural rigidity to the speaker assembly while protecting the electrical crossover components from potential damage.



Ci160RR-THX



Architectural Speaker

OBSESSED WITH HIGH RESOLUTION

Specifications

Model		Ci160RR-THX
Series		R Series
Nominal impedance		4Ω
Sensitivity (2.83V/1m)		90dB
Frequency response (±6dB) open-backed		52Hz - 24kHz
Frequency range (-10dB)"		38Hz - 30kHz
Nominal coverage		130°
Max SPL		105dB
Crossover frequency		2.1kHz
Drive units	LF	165mm (6.5in.) Uni-Q
	HF	25mm (1in.)
Recommended amplifier power		10 - 190 W
Recommended high-pass filter		38Hz
Product external dimensions	Diameter Ø	234.6mm (9.24in.)
	Depth	115mm (4.53in.)
Cut-out dimensions	Diameter Ø	196mm (7.71in.)
Net weight		2.94kg (6.48lbs.)
Mounting depth from surface		110mm (4.33in.)
Optional rough in frame		RIF160R
Optional rear enclosure		N/A
Ideal rear volume		20L
Minimum rear volume		10L
THX certification		THX® Certified Ultra
Safety and Regulatory Compliance		IP64
Ceiling thickness (Maximum)		37mm (1.46in.)
Ceiling thickness (Minimum)		5mm (0.2in.)

Ci160RR-THX

Architectural Speaker



OBSESSED WITH HIGH RESOLUTION

Directivity Index

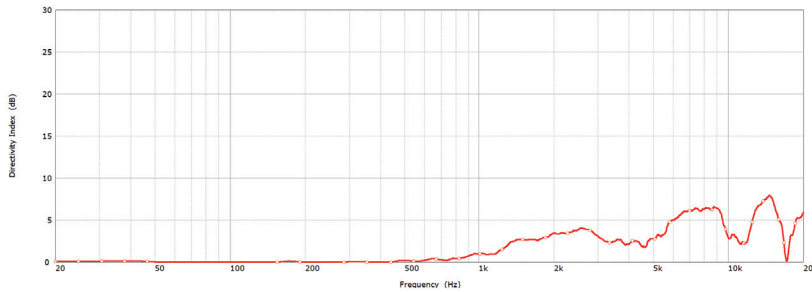

Beamwidth -3dB

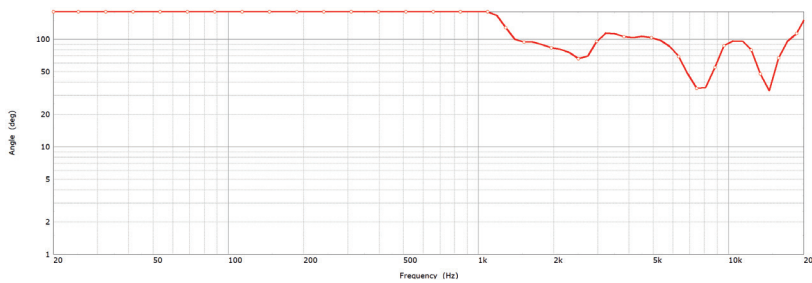

Beamwidth -6dB

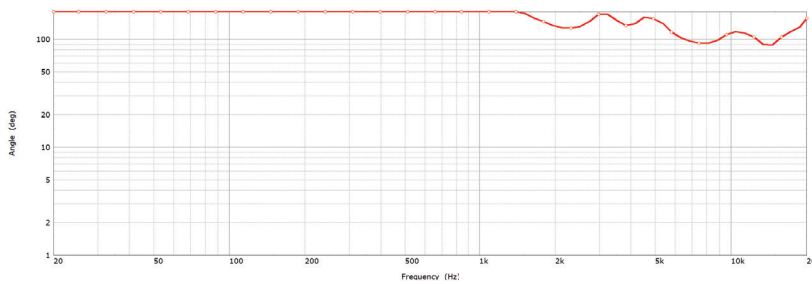

Impedance

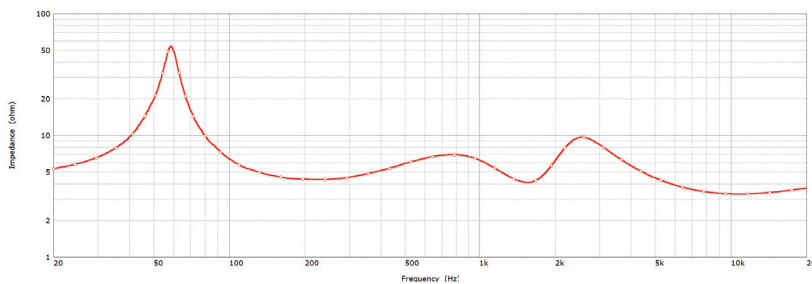

Sensitivity (2.83V/1m)

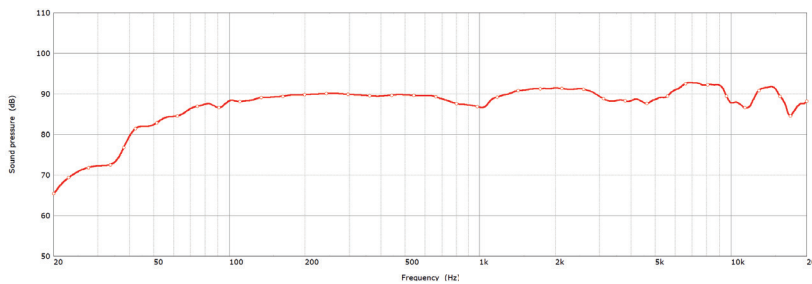

Polar Responses

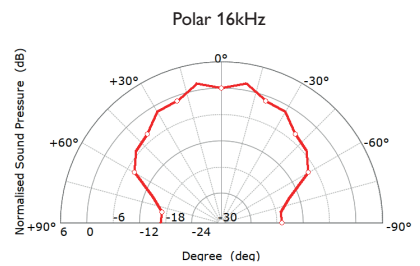
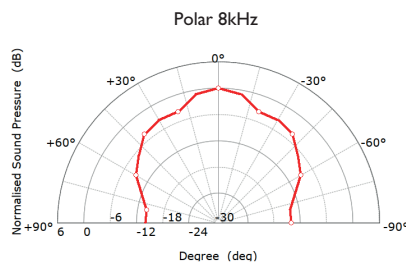
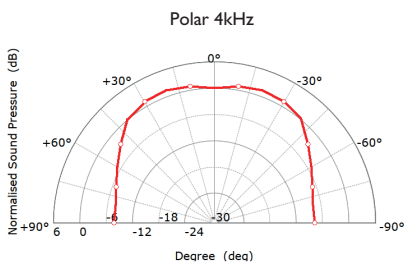
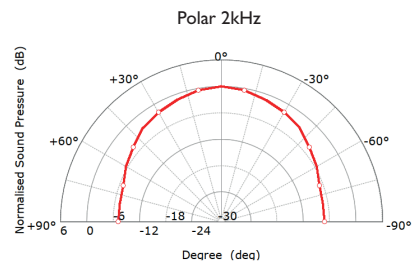
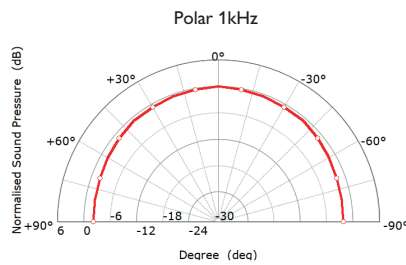
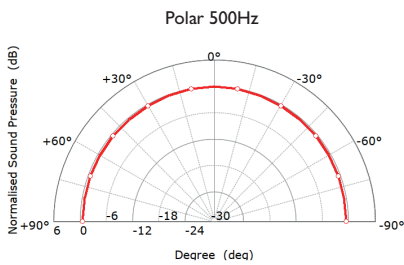
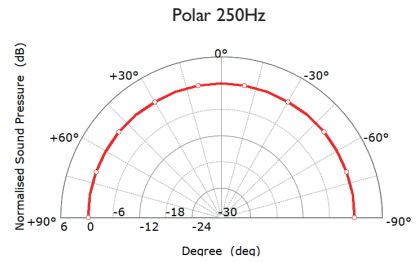
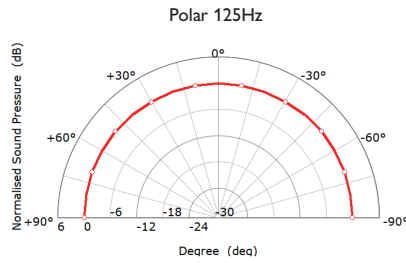
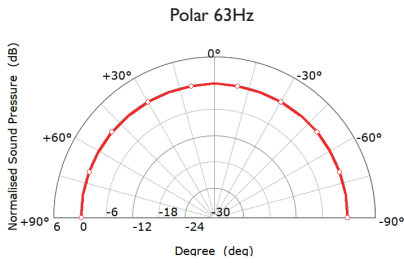

Ci160RR-THX



Architectural Speaker

OBSESSED WITH HIGH RESOLUTION

Mechanical Diagrams

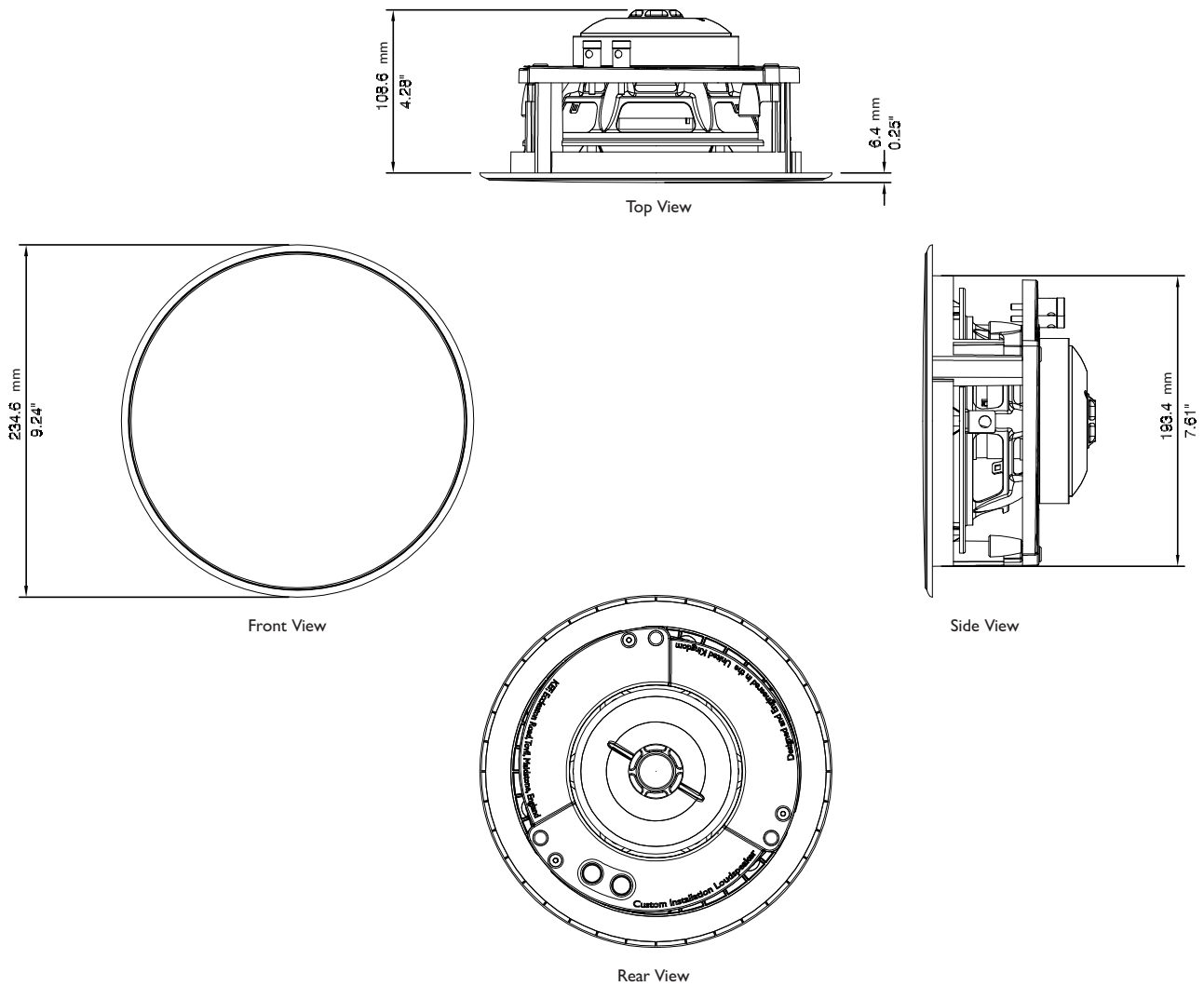

Dimensions in mm (inches)

THX and the THX Logo are the property of THX Ltd., registered in the U.S. and other countries.

Visit KEF.COM for more about KEF and its products.

KEF reserves the right, in line with continuing research and development, to amend or change specifications. E&OE.

*To meet THX Ultra distortion specifications, install with a 3 litre rear enclosure and set the A/V processor speaker size to small